

DEBRİYAJ ALT MERKEZLERİ//CLUTCH MASTER CYLINDERS
DEBRİYAJ ÜST MERKEZLERİ//CLUTCH SERVOS
KURUTUCU TAHLİYE VALFLERİ//AIR DRYERS
KÖRÜK VENTİLLERİ//VALVES
VE TAMİR TAKIMLARI//REPAIR KITS FOR THEM



2012



yumak®

www.mehmetyumak.com

Güven Duyulan Kalite





Değerli Müşterilerimiz;

YUMAK OTOMOTİV LTD.ŞTİ. adıyla 30 yılı aşkın bir süredir faaliyette bulunan, ileri teknolojisi ile gösterdiği yüksek performans ve üstün kalite seviyesi ile *kamyon* ve *tır* grupları için garantili yedek parça ve üniteler üretmekte olan firmamız müşteri memnuniyetini kendine bir kuruluş ilkesi edinmiş hem Türkiye pazarında hem de başta Avrupa ülkeleri olmak üzere uluslararası pazarlarda hak ettiği yeri almış; aranılan ve tercih edilen bir marka haline gelmiştir!

Başarımızda; tecrübemiz, kalitede devamlılık, uygun fiyata önem veren ve müşterilerimizle daima sıcak temas halinde bulunarak öneri ve isteklerine uygun hareket etmemizin büyük payı vardır. Ve her zaman daha iyiyi hedefleyen firmamız derki; **EN İYİSİ HENÜZ ÜRETİLMEDİ...!**

Dear Customers;

Our company that has been active more than 30 years under the name of YUMAK AUTOMOTIVE LTD. STI. and which produces guaranteed spare parts and units within the *truck* and *TIR* groups with high performance and high quality level it showed through its advanced technology, adopted satisfaction of customer as an institutional principle, took the place it deserved both in Turkish market and in international market, mainly in European countries; and has been a desired and preferred brand! In our success; there is always a share of our experience, continuity in quality, attaching importance to favourable price, close contact with our customers and acting in compliance with their suggestions and demands. And our company that always aimed at the better says that;

THE BEST'S NOT PRODUCED YET...!

Уважаемые покупатели,

Фирма ЮМАК ОТОМОТИВ ЛТД вот уже на протяжении 30-ти лет производит высококачественные запасные части для *грузовых автомашин* и *трейлеров* европейского производства. ЮМАК, не только один из лучших производителей в Турции, но и хорошо известная и предпочитаемая марка на международном рынке!

В успехе нашей фирмы лежат такие факторы, как уделение большого значения передовым технологиям, накопленный годами богатый опыт, высокое качество продуктов и самое главное – это наши клиенты, чьи пожелания и предложения стали путеводителем в нашем бизнесе. В своем стремлении к лучшему ЮМАК, делая акцент на качество, утверждает...

МЫ ЛУЧШИЕ!

DEBRİYAJ ALT MERKEZLERİ ve TAMİR TAKIMLARI / CLUTCH SERVOS and REPAIR KITS

YUMAK NO	REFERANCE NO	REFERANCE NO	PAGE NO	YUMAK NO	REFERANCE NO	REFERANCE NO	PAGE NO	YUMAK NO	REFERANCE NO	REFERANCE NO	PAGE NO
02.01.001	VG 3200		1	02.02.014	753259		10	02.02.057	970.051.409.0		17
02.01.002	VG 3204	637208440	1	02.02.015	970.051.151.0	000.295.0818	10	02.02.057	5010245221		17
	0659807	637208220			1518250			02.02.058	970.051.413.0		18
02.01.003	VG 3208	81.30725.6033	1	02.02.016	970.051.158.0	970.051.146.0	10	02.02.059	970.051.415.0	5010245868	18
	81.30725.6031	81.30725.6032			1506456	000.295.1518			5010452511		
02.01.004	VG 3229	81.30725.6053	1	02.02.017	970.051.159.0	000.295.1418	10	02.02.060	970.051.436.0	000.254.0347	18
	81.30725.6051				1518252				1147633		
02.01.005	VG 3261	81.30725.6065	1	02.02.018	970.051.163.0	000.295.0718	10	02.02.061	970.051.437.0		18
	1117464			02.02.019	970.051.164.0		11	02.02.062	970.051.423.0	501006570	18
02.01.006	VG 3262		2	02.02.019	000.295.1318		11		1506466	7C46 7K626AA	
02.01.008	VG 3264		2	02.02.020	970.051.165.0		11	02.02.063	970.051.407.0		19
02.01.010	VG 3213		2	02.02.020	042321100		11	02.02.064	970.051.438.0	5010452511	19
02.01.011	VG 3228		2	02.02.021	970.051.176.0	11010080	11		1519286	504103066	
02.01.012	VG 3265		2		1506459	8.919.917.784.4		02.02.066	970.051.171.0	5010244123	19
02.01.013	VG 3267		3	02.02.022	970.051.182.0		11		1519279	99434056	
02.01.014	VG 3268		3	02.02.023	970.051.204.0	0423.203.00	11	02.02.067	970.051.179.0		19
02.01.015	VG 3269		3		1519280	42062535		02.02.067	384.295.7018		19
02.01.016	VG 3275		3	02.02.024	970.051.205.0		12	02.02.068	970.051.412.0		19
02.01.017	VG 3276		3	02.02.024	1519281		12	02.02.068	81.30725.6084		19
02.01.018	VG 3238		4	02.02.025	970.051.209.0	5000673126	12	02.02.069	970.051.402.0		20
02.01.019	VG 3285		4		1518254			02.02.069	5010244401		20
02.01.021	VG 3239		4	02.02.026	970.051.210.0	4203.202.10	12	02.02.071	970.051.445.0		20
02.01.022	VG 3283		4		0097539	8.285.379.000		02.02.071	000.254.0847		20
02.01.023	VG 3284		4	02.02.027	970.051.307.0	81.30725.9064	12	02.02.072	970.051.410.0	5010245488	20
02.01.024	VG 3221		5		81.30725.6064	81.30725.6065		02.02.073	970.051.125.0		20
02.01.024	98420498		5	02.02.028	970.051.401.0		12	02.02.074	970.051.172.0		20
02.01.025	VG 3288		5	02.02.029	970.051.405.0	000.254.0047	13	02.02.075	970.051.206.0	1506461	21
02.01.026	VG 3289		5		000.295.2818			02.02.076	970.051.207.0		21
02.01.027	VG 3277		5	02.02.030	970.051.152.0	11010076	13	02.02.077	970.051.211.0		21
02.01.028	VG 3278		5		042320800			02.02.078	970.051.214.0	81.30725.6052	21
02.01.029	VG 3279		6	02.02.031	970.051.406.0	81.30725.6067	13	02.02.079	970.051.220.0	1506463	21
02.01.030	VG 3281		6		1505141	81.30725.6049			8.383.332.000B		
02.01.031	VG 3211		6	02.02.032	970.051.414.0	1518255	13	02.02.080	970.051.222.0	1519285	22
02.01.034	VG 3222		6		81.30725.6086	622500			1261878		
02.01.035	VG 3227		6	02.02.033	970.051.431.0		13	02.02.081	970.051.224.0	1519285	22
02.01.037	VG 3234		7	02.02.034	970.051.424.0		14	02.02.082	970.051.425.0		22
02.02.001	970.051.102.0		7	02.02.035	970.051.168.0		14	02.02.083	970.051.426.0		22
02.02.001	699.295.0018		7	02.02.037	970.051.136.0	0390486	14	02.02.084	970.051.429.0	5010452429	22
02.02.002	970.051.107.0	345362	7	02.02.040	970.051.156.0		14	02.02.085	970.051.430.0	5010452472	23
	1518242	343362		02.02.041	970.051.157.0	81.30725.6054	14	02.02.086	970.051.432.0	81.30725.6108	23
02.02.003	970.051.111.0	81.30725.6027	7		1518251	81.30725.6053		02.02.087	970.051.433.0	000.295.3718	23
	81.30725.6014	81.30725.6026		02.02.042	970.051.161.0		15	02.02.088	970.051.435.0		23
02.02.004	970.051.114.0	500362256	8	02.02.042	000.295.1818		15	02.02.089	970.051.439.0		23
	659807	85.30001.9892		02.02.043	970.051.162.0	000.295.1018	15	02.02.090	970.051.440.0		24
02.02.005	970.051.124.0	503135313	8		1505261			02.02.091	970.051.441.0	000.254.0247	24
	1518244	5000.787875		02.02.044	970.051.166.0	384.295.7018	15	02.02.092	970.051.443.0	000.254.0747	24
02.02.006	970.051.126.0	5000815689	8	02.02.045	970.051.169.0	8.383.331.0008	15	02.02.093	970.051.444.0		24
	1518245	42037229			1515253	0281009		02.02.094	970.051.446.0	81.30725.6100	24
02.02.007	970.051.127.0	040320100	8	02.02.046	970.051.170.0	81.30725.9062	15	02.02.095	970.051.447.0		25
	1519273	04791101			81.30725.6062			02.02.096	970.051.449.0		25
02.02.008	970.051.128.0	001.295.5607	8	02.02.047	970.051.173.0		16	02.02.097	970.051.451.0		25
	1518246			02.02.048	970.051.174.0	000.295.2318	16	02.02.098	970.051.453.0		25
02.02.009	970.051.129.0	8.285.280.000	9		1506458			02.02.099	970.051.455.0		25
	0281009	286295		02.02.049	970.051.177.0	8.919.925.013.4	16	02.02.100	970.051.457.0		26
02.02.010	970.051.131.0	001.295.6707	9	02.02.050	970.051.178.0		16	02.02.101	970.051.461.0		26
	1518247	001.295.3101		02.02.051	970.051.180.0		16	02.02.102	970.051.462.0		26
02.02.011	970.051.132.0	81.30725.6032	9	02.02.052	970.051.183.0	8.919.925.013.4	17	02.02.103	970.051.463.0		26
	1518248	81.30725.6031		02.02.054	970.051.190.0	000.254.0147	17	02.02.104	970.051.464.0		26
02.02.012	970.051.135.0		9	02.02.055	970.051.217.0	81.60725.6060	17	02.02.105	970.051.422.0		27
02.02.013	970.051.137.0	000.295.0018	9		1506462			02.02.106	970.051.191.0		27
	1518249			02.02.056	970.051.218.0	5010244109	17	02.02.107	970.051.154.0		27
02.02.014	970.051.150.0		10		1519283			02.02.108	970.051.181.0		27

ORIGINAL PART NUMBERS ARE USED SO AS TO IDENTIFY THE PRODUCTS WE SELL, IN THE SOLE PURPOSE OF CUSTOMERS RECOGNITION OF THE ITEMS SOLD.

DEBRİYAJ ALT MERKEZLERİ ve TAMİR TAKIMLARI / CLUTCH SERVOS and REPAIR KITS

YUMAK NO	REFERENCE NO	REFERENCE NO	PAGE NO	YUMAK NO	REFERENCE NO	PAGE NO	YUMAK NO	REFERENCE NO	PAGE NO
02.02.109	970.051.192.0		27	02.05.019	625384	37	RK.02.070		36
02.02.110	970.051.193.0		28	02.05.019	5010 244 208	37	RK.02.071	626731 AM	37
02.02.111	970.051.194.0		28	02.05.020	626853	37	RK.02.073	81.30725.6061	32
02.02.112	970.051.195.0		28	02.05.020	5010 245 752	37	RK.02.074		32
02.02.113	970.051.442.0		28	02.05.021	624199	37	RK.02.075	81.30725.6090	33
02.02.114	970.051.452.0		28	02.05.021	1337966	37	RK.02.080		7
02.02.115	970.051.454.0		29	02.05.022	628494	37	RK.02.081		8
02.02.116	970.051.459.0		29	02.05.023	629479	37	RK.02.082		7
02.02.117	970.051.466.0		29	RK.02.001	970.051.904.2	7	RK.02.083		8
02.03.001	APGA.1613		29	RK.02.002	970.051.906.2	27	RK.02.084		7
02.03.002	APGA.1605		29	RK.02.003	970.051.905.2	7	RK.02.085		12
02.04.001	622107		30	RK.02.004	970.051.910.2	9	RK.02.086		9
02.04.002	KA 625359		30	RK.02.005	970.051.903.2	9	RK.02.087		9
02.04.002	627692 AM		30	RK.02.006	970.051.911.2	27	RK.02.088		9
02.04.004	20524584	628492	30	RK.02.007	970.051.917.2	10	RK.02.089		13
	8171720	629276		RK.02.008	970.051.954.2	28	RK.02.090		20
02.04.005	1443530	622508	30	RK.02.009	970.051.944.2	11	RK.02.092		16
	628275	1346864		RK.02.010	970.051.916.2	10	RK.02.093		10
02.04.006	622190	622508	30	RK.02.011	970.051.909.2	12	RK.02.094		10
	374116			RK.02.012	970.051.950.2	27	RK.02.095		11
02.04.007	628036	1438606	31	RK.02.013	970.051.949.2	13	RK.02.096		19
02.04.008	628258	1443523	31	RK.02.014	970.051.943.2	26	RK.02.097		12
02.04.009	628259	1443522	31	RK.02.015	970.051.952.2	25	RK.02.098		21
02.04.010	628260	1443524	31	RK.02.016	970.051.974.2	29	RK.02.099		11
02.04.011	628447	1443533	31	RK.02.017	APGA/29069	29	RK.02.100		13
02.04.012	628448	1450047	32	RK.02.018	I 93581 / 0051	1	RK.02.101		26
02.04.013	628449	1443529	32	RK.02.019	I 83345 / 008	1	RK.02.102		12
02.04.014	625671	4200215000	32	RK.02.020	I 88094 / 0051	1	RK.02.103		26
02.04.015	625559	1318004040	32	RK.02.021		1	RK.02.104		18
02.04.016	625586	81.30725.6051	32	RK.02.022	II 31783 / 008	1	RK.02.105		22
02.04.017	628027	81307256093	33	RK.02.023	II 17767 / 0051	2	RK.02.106		28
02.04.018	626162	5010244402	33	RK.02.025	II 14195008	7	RK.02.107		13
02.04.019	625524	5010244224	33	RK.02.026	970.051.919.2	11	RK.02.108		24
02.05.002	1668501	626639am	33	RK.02.029	970.051.961.2	13	RK.02.109		13
02.05.003	626392 AM	1655639	33	RK.02.030	970.051.907.2	12	RK.02.110		14
02.05.004	628277	626786	34	RK.02.031	970.051.975.2	28	RK.02.111		11
	1346866	626708		RK.02.032	970.051.945.2	11	RK.02.112		13
02.05.005	628276	626642	34	RK.02.034		7	RK.02.113		12
	626785	622501		RK.02.036	II 35696/008	2	RK.02.114		21
02.05.006	628493	629277	34	RK.02.037	970.051.967.2	22	RK.02.115		21
02.05.007	628450	1346863	34	RK.02.040	628305	31	RK.02.116		18
02.05.008	1331770		34	RK.02.041	970.051.948.2	17	RK.02.117		19
	622199			RK.02.042	970.051.946.2	15	RK.02.118		11
02.05.009	622504	1346865	35	RK.02.043	970.051.984.2	29	RK.02.119		22
	ACU8944	1443520		RK.02.044	970.051.957.2	17	RK.02.120		17
02.05.010	627498	8171721	35	RK.02.045	1484715	30	RK.02.121		15
	624652	20524585		RK.02.046	1348878	30	RK.02.122		19
02.05.011	ACHC 450	1443531	35	RK.02.047	1443525	34	RK.02.123		23
	627499			RK.02.048	970.051.971.2	25	RK.02.124		17
02.05.012	627497	626104	35	RK.02.049	550453	30	RK.02.125		12
02.05.013	625290		35	RK.02.050	550465	30	RK.02.126		25
02.05.013	AXU 0132		35	RK.02.051	271194	33	RK.02.127		19
02.05.014	626693		36	RK.02.052	1671953	33	RK.02.128		27
02.05.014	622503		36	RK.02.053	85102142	30	RK.02.129		16
02.05.015	626397		36	RK.02.057	626733	33	RK.01.130		17
02.05.015	626479		36	RK.02.059	973.051.973.2	27	02.272		8
02.05.016	622502		36	RK.02.063	5001843783	33	02.273		7
02.05.016	175 201 1622		36	RK.02.065	1291857	35	02.276		9
02.05.017	627026		36	RK.02.066	AMPB893	35	02.277		8
02.05.017	41700		36	RK.02.067	FBU9623	35	02.279		11
02.05.018	624410		36	RK.02.068	300194-2	36			
02.05.018	520138		36	RK.02.069	626397	36			

ORIGINAL PART NUMBERS ARE USED SO AS TO IDENTIFY THE PRODUCTS WE SELL, IN THE SOLE PURPOSE OF CUSTOMERS RECOGNITION OF THE ITEMS SOLD.

DEBRİYAJ ÜST MERKEZLERİ ve TAMİR TAKIMLARI / CLUTCH MASTER CYLINDERS and REPAIR KITS

YUMAK NO	REFERANCE NO	REFERANCE NO	PAGE NO	YUMAK NO	PAGE NO
09.01.001	001.295.0307	001.295.0407	38	RK.09.009	44
09.01.002	001.295.6006	KG.2395.1.3	38	RK.09.011	45
09.01.004	001.295.2906	KG.2395.1.7	38	RK.09.012	38
09.01.005	001.295.9607	KN.28022.0.1	38	RK.09.013	39
09.01.006	000.260.6357		38	RK.09.014	38
09.01.007	001.295.9506		38	RK.09.015	38
09.01.008	001.295.7406	KG.22019.1.1	39	RK.09.016	44
09.01.009	001.295.3006	KG.2604.1.1	39	RK.09.017	38
09.01.010	001.295.4407	KN.380532	39	RK.09.018	39
09.01.011	001.430.6001	001.430.6801	39	RK.09.019	39
09.01.012	81.30716.6043		39	RK.09.023	44
09.01.014	001.295.9106	KG.20001.0.8	39	RK.09.024	45
09.01.015	81.30716.6044		40	RK.09.031	46
09.01.016	000.295.8706		40	RK.09.032	46
09.01.017	000.295.8307		40	RK.09.036	44
09.01.019	KG.2602.1.1		40	RK.09.037	44
09.01.020	001.430.7901		40	RK.09.039	38
09.01.021	000.430.8501		40	RK.09.042	45
09.01.022	81.30715.6135	KG.23030.0.2	41	RK.09.043	42
09.01.023	81.30715.6119	KG.2307.0.1	41	RK.09.045	39
09.01.025	007.420.2118	N24802C1	41	RK.09.046	40
09.01.026	002.295.1006		41	RK.09.047	40
09.01.027	001.260.3463	626597AM	41	RK.09.049	39
09.01.029	8172824	KG.28019.4.1	41	RK.09.052	41
09.01.031	000.295.6706	KG.3401.0.2	42	RK.09.053	39
09.01.032	81.30715.6051	KG.3401.0.1	42	RK.09.054	41
09.01.033	1506121	KN.38017.3.5	42	RK.09.055	40
09.01.034	1355979	KN.38017.3.6	42	RK.09.056	40
09.01.035	002.260.0663	001.260.1863	42	RK.09.057	40
09.01.036	42037645	KN.25020B1	42	RK.09.058	40
09.01.038	001.295.4006	KG.19046.1.2	43	RK.09.059	41
09.01.039	001.295.5206	001.295.9606	43	RK.09.060	41
09.01.040	002.295.0707	KN.28027A1	43	RK.09.061	41
09.01.042		KG.2394.1.12	43	RK.09.063	42
09.01.043		KN.3406E66	43	RK.09.065	42
09.01.044		KG.26703.1.1	43	RK.09.066	43
09.02.002	1669488	KG.28014.1.1	44	RK.09.067	43
09.02.003	001.295.5306	KG.23021.1.2	44	RK.09.068	43
09.02.006	1628218	KG.28012.0.1	44	RK.09.069	43
09.03.007	355973	KG.2595.1.4	44	RK.09.070	43
09.04.002	1348734	626761AM	44	RK.09.071	43
09.04.003	1348735	626762AM	44	RK.09.072	45
09.04.004	096392	KG.250001.0.2	45	RK.09.073	44
09.04.005	1348733	323760AM	45	RK.09.075	45
09.04.006	ACHD274	625826AM	45	RK.09.076	47
09.05.001		627233AM	45	RK.09.077	47
09.05.002	1361136	KG.250004.0.2	45	RK.09.078	47
09.05.010	626169AM	625536AM	45	RK.09.079	47
09.06.002	81.30716.6082	KN.28014C1	46	RK.09.080	47
09.06.004	81.30716.6020	KN.28013.A.1	46	RK.09.081	46
09.07.001	ø26	623104AM	46	RK.09.082	46
09.07.002	ø28	623105AM	46		
09.07.003	ø26	623106AM	46		
09.07.004	ø28	626159AM	46		
09.09.001		KG.3106.0.1	47		
09.09.003	002.430.1401	002.430.4101	47		
09.09.004	9K1591		47		
09.09.006	FD 2704		47		
09.09.009		KG.23017.1.1	47		

DEBRİYAJ ÜST MERKEZLERİ ve TAMİR TAKIMLARI / CLUTCH MASTER CYLINDERS and REPAIR KITS

YUMAK NO	REFERANCE NO	REFERANCE NO	PAGE NO	YUMAK NO	PAGE NO
09.01.001	001.295.0307	001.295.0407	38	RK.09.009	44
09.01.002	001.295.6006	KG.2395.1.3	38	RK.09.011	45
09.01.004	001.295.2906	KG.2395.1.7	38	RK.09.012	38
09.01.005	001.295.9607	KN.28022.0.1	38	RK.09.013	39
09.01.006	000.260.6357		38	RK.09.014	38
09.01.007	001.295.9506		38	RK.09.015	38
09.01.008	001.295.7406	KG.22019.1.1	39	RK.09.016	44
09.01.009	001.295.3006	KG.2604.1.1	39	RK.09.017	38
09.01.010	001.295.4407	KN.380532	39	RK.09.018	39
09.01.011	001.430.6001	001.430.6801	39	RK.09.019	39
09.01.012	81.30716.6043		39	RK.09.023	44
09.01.014	001.295.9106	KG.20001.0.8	39	RK.09.024	45
09.01.015	81.30716.6044		40	RK.09.031	46
09.01.016	000.295.8706		40	RK.09.032	46
09.01.017	000.295.8307		40	RK.09.036	44
09.01.019	KG.2602.1.1		40	RK.09.037	44
09.01.020	001.430.7901		40	RK.09.039	38
09.01.021	000.430.8501		40	RK.09.042	45
09.01.022	81.30715.6135	KG.23030.0.2	41	RK.09.043	42
09.01.023	81.30715.6119	KG.2307.0.1	41	RK.09.045	39
09.01.025	007.420.2118	N24802C1	41	RK.09.046	40
09.01.026	002.295.1006		41	RK.09.047	40
09.01.027	001.260.3463	626597AM	41	RK.09.049	39
09.01.029	8172824	KG.28019.4.1	41	RK.09.052	41
09.01.031	000.295.6706	KG.3401.0.2	42	RK.09.053	39
09.01.032	81.30715.6051	KG.3401.0.1	42	RK.09.054	41
09.01.033	1506121	KN.38017.3.5	42	RK.09.055	40
09.01.034	1355979	KN.38017.3.6	42	RK.09.056	40
09.01.035	002.260.0663	001.260.1863	42	RK.09.057	40
09.01.036	42037645	KN.25020B1	42	RK.09.058	40
09.01.038	001.295.4006	KG.19046.1.2	43	RK.09.059	41
09.01.039	001.295.5206	001.295.9606	43	RK.09.060	41
09.01.040	002.295.0707	KN.28027A1	43	RK.09.061	41
09.01.042		KG.2394.1.12	43	RK.09.063	42
09.01.043		KN.3406E66	43	RK.09.065	42
09.01.044		KG.26703.1.1	43	RK.09.066	43
09.02.002	1669488	KG.28014.1.1	44	RK.09.067	43
09.02.003	001.295.5306	KG.23021.1.2	44	RK.09.068	43
09.02.006	1628218	KG.28012.0.1	44	RK.09.069	43
09.03.007	355973	KG.2595.1.4	44	RK.09.070	43
09.04.002	1348734	626761AM	44	RK.09.071	43
09.04.003	1348735	626762AM	44	RK.09.072	45
09.04.004	096392	KG.250001.0.2	45	RK.09.073	44
09.04.005	1348733	323760AM	45	RK.09.075	45
09.04.006	ACHD274	625826AM	45	RK.09.076	47
09.05.001		627233AM	45	RK.09.077	47
09.05.002	1361136	KG.250004.0.2	45	RK.09.078	47
09.05.010	626169AM	625536AM	45	RK.09.079	47
09.06.002	81.30716.6082	KN.28014C1	46	RK.09.080	47
09.06.004	81.30716.6020	KN.28013.A.1	46	RK.09.081	46
09.07.001	ø26	623104AM	46	RK.09.082	46
09.07.002	ø28	623105AM	46		
09.07.003	ø26	623106AM	46		
09.07.004	ø28	626159AM	46		
09.09.001		KG.3106.0.1	47		
09.09.003	002.430.1401	002.430.4101	47		
09.09.004	9K1591		47		
09.09.006	FD 2704		47		
09.09.009		KG.23017.1.1	47		

VENTİL GRUBU ve DİĞER PARÇALAR / VALVE GROUP and OTHER PARTS

YUMAK NO	REFERENCE NO	PAGE NO	YUMAK NO	REFERENCE NO	PAGE NO	YUMAK NO	REFERENCE NO	PAGE NO
06.01.006	0.500.005.102	53	06.02.078	SV 1425	55	12.01.014	973.001.210.0	58
06.01.011	0.500.005.104	53	06.02.079	SV 1426	55	12.01.015	973.001.012.0	58
06.01.012	0.500.005.105	53	06.02.080	SV 1380	55	12.01.016	973.001.014.0	58
RK.06.001	1507010007	53	06.02.081	SV 1418	55	12.01.017	973.001.220.0	58
06.02.001	SV 1294	54	06.02.082	SV 1440	55	RK.12.001	973.001.000.2	58
06.02.002	SV 1307	54	06.02.083	SV 1447	55	12.01.005	973.001.221.0	58
06.02.003	SV 1310	54	06.02.084	SV 1466	55	12.01.004	973.001.120.0	58
06.02.008	SV 1260	54	06.02.085	SV 1465	55	12.01.018	973.001.021.0	58
06.02.010	SV 1278	54	06.02.086	SV 1403	55	RK.12.005	973.001.006.2	58
06.02.011	SV 1361	54	06.02.087	SV 1404	55	12.01.011	973.011.000.0	58
06.02.013	SV 1412	54	06.02.088	SV 1416	55	12.01.012	973.011.001.0	58
06.02.014	SV 1468	54	06.02.089	SV 1417	55	RK.12.006	973.011.002.2	58
06.02.015	SV 1411	54	06.02.090	SV 1421	55	03.06.002	932.400.001.0	59
06.02.035	SV 1271	54	06.02.091	SV 1422	55	03.06.003	932.400.006.0	59
06.02.039	SV 1339	54	06.02.092	SV 1427	55	03.06.004	932.500.006.0	59
06.02.040	SV 1340	54	06.02.093	SV 1428	55	05.01.031	934.714.010.0	59
06.02.046	SV 1433	54	06.02.094	SV 1429	55	05.01.032	934.714.152.0	59
06.02.054	SV 1288	54	06.02.095	SV 1430	55	05.02.002	AE 4158	59
06.02.055	SV 1455	54	06.02.096	SV 1435	55	05.02.004	AE 4162	59
06.02.058	SV 1279	54	06.02.097	SV 1436	55	05.02.009	AE 4609	59
06.02.067	SV 1483	54	06.02.098	SV 1437	55	05.05.001	201.002.001	59
06.02.072	SV 1345	54	06.02.099	SV 1441	55	12.01.021	973.011.200.0	59
06.02.101	SV 1445	54	06.02.100	SV 1443	55	12.02.001	973.006.003.0	60
06.02.102	SV 1494	54	RK.06.006	I 74651	55	12.02.002	973.006.000.0	60
06.02.103	SV 1372	54	06.04.002	464.006.002.0	56	12.02.003	973.006.001.0	60
06.02.104	SV 1367	54	06.04.003	464.006.004.0	56	78.01.003	0.484.451.013	60
06.02.105	SV 1486	54	06.04.004	464.006.000.0	56	11.01.001	475.715.500.0	60
06.02.106	SV 1487	54	06.04.007	464.006.100.0	56	RK.11.004	475.715.500.2	60
06.02.004	SV 1295	54	06.04.008	464.006.001.0	56	11.01.002	475.712.500.0	60
06.02.016	SV 1323	54	06.04.011	464.006.005.0	56	RK.11.002	475.712.000.2	60
06.02.017	SV 1399	54	06.04.012	464.006.006.0	56	11.01.005	475.710.136.0	60
06.02.018	SV 1318	54	06.04.013	464.006.007.0	56	RK.11.006	475.710.001.2	60
06.02.019	SV 1321	54	06.04.014	464.006.009.0	56	11.02.001	475.604.010.0	61
06.02.020	SV 1328	54	06.04.015	464.006.012.0	56	RK.11.005	475.604.002.2	61
06.02.032	SV 1351	54	RK.06.003	464.006.000.2	56	04.01.001	461.315.008.0	61
06.02.066	SV 1434	54	05.01.001	934.702.300.0	57	RK.04.001	461.315.005.2	61
06.02.076	SV 1352	54	05.01.002	934.702.381.0	57	04.02.001	461.319.0008.0	61
06.02.107	SV 1432	54	05.01.005	934.702.042.0	57	RK.04.002	461.319.007.2	61
06.02.108	SV 1431	54	05.01.006	934.702.302.0	57	20.01.001	SV 3367	61
06.02.109	SV 1395	54	05.01.008	934.702.110.0	57	RK.20.007		61
RK.06.004	I 755223	54	05.01.010	934.702.000.0	57	20.01.003	3092123	61
RK.06.005		54	05.01.011	934.702.002.0	57	RK.20.001		61
06.02.005	SV 1281	55	05.01.012	934.702.005.0	57	20.01.016	1068952	62
06.02.007	SV 1280	55	05.01.013	934.702.040.0	57	RK.20.010		62
06.02.021	SV 1381	55	05.01.014	934.702.041.0	57	20.01.004	1068951	62
06.02.022	SV 1419	55	05.01.015	934.702.045.0	57	RK.20.008		62
06.02.023	SV 1329	55	05.01.016	934.702.047.0	57	20.01.008	SV 3302	62
06.02.024	SV 1330	55	05.01.017	934.702.082.0	57	RK.20.003		62
06.02.025	SV 1370	55	05.01.018	934.702.100.0	57	20.01.011	002.260.2457	62
06.02.026	SV 1377	55	05.01.019	934.702.320.0	57	RK.20.013		62
06.02.027	SV 1378	55	05.01.020	934.702.322.0	57	20.01.007	1319557	62
06.02.028	SV 1284	55	05.01.021	934.701.101.0	57	20.01.004	1669297	62
06.02.029	SV 1287	55	05.01.003	934.702.221.0	57	04.02.005	463.032.020.0	63
06.02.030	SV 1301	55	05.01.004	934.702.210.0	57	04.02.010	HB 1176	63
06.02.031	SV 1303	55	05.01.022	934.702.220.0	57	12.03.007	SV 3111	63
06.02.033	SV 1363	55	05.01.023	934.702.223.0	57	12.03.012	SV 3115	63
06.02.034	SV 1325	55	05.01.024	934.702.240.0	57	06.04.016	464.007.002.0	63
06.02.052	SV 1409	55	RK.05.001	934.702.004.2	57	20.01.005	SV 3371	63
06.02.056	SV 1410	55	RK.05.002	934.702.005.2	57	20.01.009	1334037	63
06.02.057	SV 1298	55	12.01.001	973.001.020.0	58	20.01.010	1303948	63
06.02.065	SV 1299	55	12.01.002	973.001.010.0	58	83.01.001	0.481.009.022	63
06.02.077	SV 1442	55	12.01.013	973.001.016.0	58	51.01.006	DR 5118	63

CLUTCH SERVOS and REPAIR KITS / DEBRİYAJ ALT MERKEZLERİ ve TAMİR TAKIMLARI

REFERANCE NO	YUMAK NO	PAGE NO	REFERANCE NO	YUMAK NO	PAGE NO	REFERANCE NO	YUMAK NO	PAGE NO
VG 3200	02.01.001	1	42037229	02.02.006	8	81.30725.9064	02.02.027	12
VG 3204	02.01.002	1	1518245	02.02.006	8	81.30725.6065	02.02.027	12
0659807	02.01.002	1	970.051.127.0	02.02.007	8	81.30725.6064	02.02.027	12
637208440	02.01.002	1	040320100	02.02.007	8	970.051.401.0	02.02.028	12
637208220	02.01.002	1	04791101	02.02.007	8	970.051.405.0	02.02.029	13
VG 3208	02.01.003	1	1519273	02.02.007	8	000.254.0047	02.02.029	13
81.30725.6033	02.01.003	1	970.051.128.0	02.02.008	8	000.295.2818	02.02.029	13
81.30725.6032	02.01.003	1	001.295.5607	02.02.008	8	970.051.152.0	02.02.030	13
81.30725.6031	02.01.003	1	1518246	02.02.008	8	11010076	02.02.030	13
VG 3229	02.01.004	1	970.051.129.0	02.02.009	9	042320800	02.02.030	13
81.30725.6053	02.01.004	1	8.285.280.000	02.02.009	9	970.051.406.0	02.02.031	13
81.30725.6051	02.01.004	1	286295	02.02.009	9	81.30725.6067	02.02.031	13
VG 3261	02.01.005	1	0281009	02.02.009	9	81.30725.6049	02.02.031	13
81.30725.6065	02.01.005	1	970.051.131.0	02.02.010	9	1505141	02.02.031	13
II17464	02.01.005	1	001.295.6707	02.02.010	9	970.051.414.0	02.02.032	13
VG 3262	02.01.006	2	001.295.3101	02.02.010	9	1518255	02.02.032	13
VG 3264	02.01.008	2	1518247	02.02.010	9	622500	02.02.032	13
VG 3213	02.01.010	2	970.051.132.0	02.02.011	9	81.30725.6086	02.02.032	13
VG 3228	02.01.011	2	81.30725.6032	02.02.011	9	970.051.431.0	02.02.033	13
VG 3265	02.01.012	2	81.30725.6031	02.02.011	9	970.051.424.0	02.02.034	14
VG 3267	02.01.013	3	1518248	02.02.011	9	970.051.188.0	02.02.035	14
VG 3268	02.01.014	3	970.051.135.0	02.02.012	9	970.051.136.0	02.02.037	14
VG 3269	02.01.015	3	970.051.137.0	02.02.013	9	0390486	02.02.037	14
VG 3275	02.01.016	3	000.295.0018	02.02.013	9	970.051.156.0	02.02.040	14
VG 3276	02.01.017	3	1518249	02.02.013	9	970.051.157.0	02.02.041	14
VG 3238	02.01.018	4	970.051.150.0	02.02.014	10	81.30725.6054	02.02.041	14
VG 3285	02.01.019	4	753259	02.02.014	10	81.30725.6053	02.02.041	14
VG 3239	02.01.021	4	970.051.151.0	02.02.015	10	1518251	02.02.041	14
VG 3283	02.01.022	4	000.295.0818	02.02.015	10	970.051.161.0	02.02.042	15
VG 3284	02.01.023	4	1518250	02.02.015	10	000.295.1818	02.02.042	15
VG 3221	02.01.024	5	970.051.158.0	02.02.016	10	970.051.162.0	02.02.043	15
98420498	02.01.024	5	970.051.146.0	02.02.016	10	000.295.1018	02.02.043	15
VG 3288	02.01.025	5	000.295.1518	02.02.016	10	1505261	02.02.043	15
VG 3289	02.01.026	5	1506456	02.02.016	10	970.051.166.0	02.02.044	15
VG 3277	02.01.027	5	970.051.159.0	02.02.017	10	384.295.7018	02.02.044	15
VG 3278	02.01.028	5	000.295.1418	02.02.017	10	970.051.169.0	02.02.045	15
VG 3279	02.01.029	6	1518252	02.02.017	10	8.383.331.0008	02.02.045	15
VG 3281	02.01.030	6	970.051.163.0	02.02.018	10	0281009	02.02.045	15
VG 3211	02.01.031	6	000.295.0718	02.02.018	10	1515253	02.02.045	15
VG 3222	02.01.034	6	970.051.164.0	02.02.019	11	970.051.170.0	02.02.046	15
VG 3227	02.01.035	6	000.295.1318	02.02.019	11	81.30725.9062	02.02.046	15
VG 3234	02.01.037	7	970.051.165.0	02.02.020	11	81.30725.6062	02.02.046	15
970.051.102.0	02.02.001	7	042321100	02.02.020	11	970.051.173.0	02.02.047	16
699.295.0018	02.02.001	7	970.051.176.0	02.02.021	11	970.051.174.0	02.02.048	16
970.051.107.0	02.02.002	7	11010080	02.02.021	11	000.295.2318	02.02.048	16
345362	02.02.002	7	8.919.917.784.4	02.02.021	11	1506458	02.02.048	16
343362	02.02.002	7	1506459	02.02.021	11	970.051.177.0	02.02.049	16
1518242	02.02.002	7	970.051.182.0	02.02.022	11	8.919.925.013.4	02.02.049	16
970.051.111.0	02.02.003	7	970.051.204.0	02.02.023	11	970.051.178.0	02.02.050	16
81.30725.6027	02.02.003	7	0423.203.00	02.02.023	11	970.051.180.0	02.02.051	16
81.30725.6026	02.02.003	7	42062535	02.02.023	11	970.051.183.0	02.02.052	17
81.30725.6014	02.02.003	7	1519280	02.02.023	11	8.919.925.013.4	02.02.052	17
970.051.114.0	02.02.004	8	970.051.205.0	02.02.024	12	970.051.190.0	02.02.054	17
500362256	02.02.004	8	1519281	02.02.024	12	000.254.0147	02.02.054	17
85.30001.9892	02.02.004	8	970.051.209.0	02.02.025	12	970.051.217.0	02.02.055	17
659807	02.02.004	8	5000673126	02.02.025	12	81.60725.6060	02.02.055	17
970.051.124.0	02.02.005	8	1518254	02.02.025	12	1506462	02.02.055	17
503135313	02.02.005	8	970.051.210.0	02.02.026	12	970.051.218.0	02.02.056	17
5000.787875	02.02.005	8	4203.202.10	02.02.026	12	5010244109	02.02.056	17
1518244	02.02.005	8	8.285.379.000	02.02.026	12	1519283	02.02.056	17
970.051.126.0	02.02.006	8	0097539	02.02.026	12	970.051.409.0	02.02.057	17
5000815689	02.02.006	8	970.051.307.0	02.02.027	12	5010245221	02.02.057	17

ORIGINAL PART NUMBERS ARE USED SO AS TO IDENTIFY THE PRODUCTS WE SELL, IN THE SOLE PURPOSE OF CUSTOMERS RECOGNITION OF THE ITEMS SOLD.

CLUTCH SERVOS and REPAIR KITS / DEBRİYAJ ALT MERKEZLERİ ve TAMİR TAKIMLARI

REFERANCE NO	YUMAK NO	PAGE NO	REFERANCE NO	YUMAK NO	PAGE NO	REFERANCE NO	YUMAK NO	PAGE NO
970.051.413.0	02.02.058	18	970.051.443.0	02.02.092	24	625586	02.04.016	32
970.051.415.0	02.02.059	18	000.254.0747	02.02.092	24	81.30725.6051	02.04.016	32
5010245868	02.02.059	18	970.051.444.0	02.02.093	24	628027	02.04.017	33
5010452511	02.02.059	18	970.051.446.0	02.02.094	24	81307256093	02.04.017	33
970.051.436.0	02.02.060	18	81.30725.6100	02.02.094	24	626162	02.04.018	33
000.254.0347	02.02.060	18	970.051.447.0	02.02.095	25	5010244402	02.04.018	33
1147633	02.02.060	18	970.051.449.0	02.02.096	25	625524	02.04.019	33
970.051.437.0	02.02.061	18	970.051.451.0	02.02.097	25	5010244224	02.04.019	33
970.051.423.0	02.02.062	18	970.051.453.0	02.02.098	25	1668501	02.05.002	33
501006570	02.02.062	18	970.051.455.0	02.02.099	25	626639am	02.05.002	33
7C46 7K626AA	02.02.062	18	970.051.457.0	02.02.100	26	626392 AM	02.05.003	33
1506466	02.02.062	18	970.051.461.0	02.02.101	26	1655639	02.05.003	33
970.051.407.0	02.02.063	19	970.051.462.0	02.02.102	26	628277	02.05.004	34
970.051.438.0	02.02.064	19	970.051.463.0	02.02.103	26	626786	02.05.004	34
5010452511	02.02.064	19	970.051.464.0	02.02.104	26	626708	02.05.004	34
504103066	02.02.064	19	970.051.422.0	02.02.105	27	1346866	02.05.004	34
1519286	02.02.064	19	970.051.191.0	02.02.106	27	628276	02.05.005	34
970.051.171.0	02.02.066	19	970.051.154.0	02.02.107	27	626642	02.05.005	34
5010244123	02.02.066	19	970.051.181.0	02.02.108	27	622501	02.05.005	34
99434056	02.02.066	19	970.051.192.0	02.02.109	27	626785	02.05.005	34
1519279	02.02.066	19	970.051.193.0	02.02.110	28	628493	02.05.006	34
970.051.179.0	02.02.067	19	970.051.194.0	02.02.111	28	629277	02.05.006	34
384.295.7018	02.02.067	19	970.051.195.0	02.02.112	28	628450	02.05.007	34
970.051.412.0	02.02.068	19	970.051.442.0	02.02.113	28	1346863	02.05.007	34
81.30725.6084	02.02.068	19	970.051.452.0	02.02.114	28	1331770	02.05.008	34
970.051.402.0	02.02.069	20	970.051.454.0	02.02.115	29	622199	02.05.008	34
5010244401	02.02.069	20	970.051.459.0	02.02.116	29	622504	02.05.009	35
970.051.445.0	02.02.071	20	970.051.466.0	02.02.117	29	1346865	02.05.009	35
000.254.0847	02.02.071	20	APGA.1613	02.03.001	29	1443520	02.05.009	35
970.051.410.0	02.02.072	20	APGA.1605	02.03.002	29	ACU8944	02.05.009	35
5010245488	02.02.072	20	622107	02.04.001	30	627498	02.05.010	35
970.051.125.0	02.02.073	20	KA 625359	02.04.002	30	8171721	02.05.010	35
970.051.172.0	02.02.074	20	627692 AM	02.04.002	30	20524585	02.05.010	35
970.051.206.0	02.02.075	21	20524584	02.04.004	30	624652	02.05.010	35
1506461	02.02.075	21	628492	02.04.004	30	ACHC 450	02.05.011	35
970.051.207.0	02.02.076	21	629276	02.04.004	30	1443531	02.05.011	35
970.051.211.0	02.02.077	21	8171720	02.04.004	30	627499	02.05.011	35
970.051.214.0	02.02.078	21	1443530	02.04.005	30	627497	02.05.012	35
81.30725.6052	02.02.078	21	622508	02.04.005	30	626104	02.05.012	35
970.051.220.0	02.02.079	21	1346864	02.04.005	30	625290	02.05.013	35
1506463	02.02.079	21	628275	02.04.005	30	AXU 0132	02.05.013	35
8.383.332.000B	02.02.079	21	622190	02.04.006	30	626693	02.05.014	36
970.051.222.0	02.02.080	22	622508	02.04.006	30	622503	02.05.014	36
1519285	02.02.080	22	374116	02.04.006	30	626397	02.05.015	36
1261878	02.02.080	22	628036	02.04.007	31	626479	02.05.015	36
970.051.224.0	02.02.081	22	1438606	02.04.007	31	622502	02.05.016	36
1519285	02.02.081	22	628258	02.04.008	31	175 201 1622	02.05.016	36
970.051.425.0	02.02.082	22	1443523	02.04.008	31	627026	02.05.017	36
970.051.426.0	02.02.083	22	628259	02.04.009	31	41700	02.05.017	36
970.051.429.0	02.02.084	22	1443522	02.04.009	31	624410	02.05.018	36
5010452429	02.02.084	22	628260	02.04.010	31	520138	02.05.018	36
970.051.430.0	02.02.085	23	1443524	02.04.010	31	625384	02.05.019	37
5010452472	02.02.085	23	628447	02.04.011	31	5010 244 208	02.05.019	37
970.051.432.0	02.02.086	23	1443533	02.04.011	31	626853	02.05.020	37
81.30725.6108	02.02.086	23	628448	02.04.012	32	5010 245 752	02.05.020	37
970.051.433.0	02.02.087	23	1450047	02.04.012	32	624199	02.05.021	37
000.295.3718	02.02.087	23	628449	02.04.013	32	1337966	02.05.021	37
970.051.435.0	02.02.088	23	1443529	02.04.013	32	628494	02.05.022	37
970.051.439.0	02.02.089	23	625671	02.04.014	32	629479	02.05.023	37
970.051.440.0	02.02.090	24	4200215000	02.04.014	32			
970.051.441.0	02.02.091	24	625559	02.04.015	32			
000.254.0247	02.02.091	24	1318004040	02.04.015	32			

CLUTCH SERVOS and REPAIR KITS / DEBRİYAJ ALT MERKEZLERİ ve TAMİR TAKIMLARI

REFERANCE NO	YUMAK NO	PAGE NO	REFERANCE NO	YUMAK NO	PAGE NO	REFERANCE NO	YUMAK NO	PAGE NO
626397	RK.02.069	36	000.260.6357	09.01.006	38	ACHD274	09.04.006	45
628305	RK.02.040	31	000.295.6706	09.01.031	42	FD 2704	09.09.006	47
1291857	RK.02.065	35	000.295.8307	09.01.017	40	KG.19046.1.2	09.01.038	43
1443525	RK.02.047	34	000.295.8706	09.01.016	40	KG.20001.0.8	09.01.014	39
1484715	RK.02.045	30	000.430.8501	09.01.021	40	KG.22019.1.1	09.01.008	39
1671953	RK.02.052	33	001.260.1863	09.01.035	42	KG.23017.1.1	09.09.009	47
85102142	RK.02.053	30	001.260.3463	09.01.027	41	KG.23021.1.2	09.02.003	44
1348878	RK.02.046	30	001.295.0307	09.01.001	38	KG.23030.0.2	09.01.022	41
271194	RK.02.051	33	001.295.0407	09.01.001	38	KG.2307.0.1	09.01.023	41
300194-2	RK.02.068	36	001.295.2906	09.01.004	38	KG.2394.1.12	09.01.042	43
5001843783	RK.02.063	33	001.295.3006	09.01.009	39	KG.2395.1.3	09.01.002	38
550453	RK.02.049	30	001.295.4006	09.01.038	43	KG.2395.1.7	09.01.004	38
550465	RK.02.050	30	001.295.4407	09.01.010	39	KG.250001.0.2	09.04.004	45
626731 AM	RK.02.071	37	001.295.5206	09.01.039	43	KG.250004.0.2	09.05.002	45
626733	RK.02.057	33	001.295.5306	09.02.003	44	KG.2595.1.4	09.03.007	44
81.30725.6061	RK.02.073	32	001.295.6006	09.01.002	38	KG.2602.1.1	09.01.019	40
81.30725.6090	RK.02.075	33	001.295.7406	09.01.008	39	KG.2604.1.1	09.01.009	39
970.051.903.2	RK.02.005	9	001.295.9106	09.01.014	39	KG.26703.1.1	09.01.044	43
970.051.904.2	RK.02.001	7	001.295.9506	09.01.007	38	KG.28012.0.1	09.02.006	44
970.051.905.2	RK.02.003	7	001.295.9606	09.01.039	43	KG.28014.1.1	09.02.002	44
970.051.906.2	RK.02.002	27	001.295.9607	09.01.005	38	KG.28019.4.1	09.01.029	41
970.051.907.2	RK.02.030	12	001.430.6001	09.01.011	39	KG.3106.0.1	09.09.001	47
970.051.909.2	RK.02.011	12	001.430.6801	09.01.011	39	KG.3401.0.1	09.01.032	42
970.051.910.2	RK.02.004	9	001.430.7901	09.01.020	40	KG.3401.0.2	09.01.031	42
970.051.911.2	RK.02.006	27	002.260.0663	09.01.035	42	KN.25020B1	09.01.036	42
970.051.916.2	RK.02.010	10	002.295.0707	09.01.040	43	KN.28013.A.1	09.06.004	46
970.051.917.2	RK.02.007	10	002.295.1006	09.01.026	41	KN.28014C1	09.06.002	46
970.051.919.2	RK.02.026	11	002.430.1401	09.09.003	47	KN.28022.0.1	09.01.005	38
970.051.943.2	RK.02.014	26	002.430.4101	09.09.003	47	KN.28027A1	09.01.040	43
970.051.944.2	RK.02.009	11	007.420.2118	09.01.025	41	KN.3406E66	09.01.043	43
970.051.945.2	RK.02.032	11	096392	09.04.004	45	KN.38017.3.5	09.01.033	42
970.051.946.2	RK.02.042	15	1348733	09.04.005	45	KN.38017.3.6	09.01.034	42
970.051.948.2	RK.02.041	17	1348734	09.04.002	44	KN.380532	09.01.010	39
970.051.949.2	RK.02.013	13	1348735	09.04.003	44	N24802C1	09.01.025	41
970.051.950.2	RK.02.012	27	1355979	09.01.034	42			
970.051.952.2	RK.02.015	25	1361136	09.05.002	45			
970.051.954.2	RK.02.008	28	1506121	09.01.033	42			
970.051.957.2	RK.02.044	17	1628218	09.02.006	44			
970.051.961.2	RK.02.029	13	1669488	09.02.002	44			
970.051.967.2	RK.02.037	22	323760AM	09.04.005	45			
970.051.971.2	RK.02.048	25	355973	09.03.007	44			
970.051.974.2	RK.02.016	29	42037645	09.01.036	42			
970.051.975.2	RK.02.031	28	623104AM	09.07.001	46			
970.051.984.2	RK.02.043	29	623105AM	09.07.002	46			
973.051.973.2	RK.02.059	27	623106AM	09.07.003	46			
AMPB893	RK.02.066	35	625536AM	09.05.010	45			
APGA/29069	RK.02.017	29	625826AM	09.04.006	45			
FBU9623	RK.02.067	35	626159AM	09.07.004	46			
I 83345 / 008	RK.02.019	1	626169AM	09.05.010	45			
I 88094 / 0051	RK.02.020	1	626597AM	09.01.027	41			
I 93581 / 0051	RK.02.018	1	626761AM	09.04.002	44			
II 14195008	RK.02.025	7	626762AM	09.04.003	44			
II 17767 / 0051	RK.02.023	2	627233AM	09.05.001	45			
II 31783 / 008	RK.02.022	1	81.30715.6051	09.01.032	42			
II 35696/008	RK.02.036	2	81.30715.6119	09.01.023	41			
			81.30715.6135	09.01.022	41			
			81.30716.6020	09.06.004	46			
			81.30716.6043	09.01.012	39			
			81.30716.6044	09.01.015	40			
			81.30716.6082	09.06.002	46			
			8172824	09.01.029	41			
			9K1591	09.09.004	47			

CLUTCH SERVOS and REPAIR KITS / DEBRİYAJ ALT MERKEZLERİ ve TAMİR TAKIMLARI

REFERANCE NO	YUMAK NO	PAGE NO	REFERANCE NO	YUMAK NO	PAGE NO	REFERANCE NO	YUMAK NO	PAGE NO
626397	RK.02.069	36	000.260.6357	09.01.006	38	ACHD274	09.04.006	45
628305	RK.02.040	31	000.295.6706	09.01.031	42	FD 2704	09.09.006	47
1291857	RK.02.065	35	000.295.8307	09.01.017	40	KG.19046.1.2	09.01.038	43
1443525	RK.02.047	34	000.295.8706	09.01.016	40	KG.20001.0.8	09.01.014	39
1484715	RK.02.045	30	000.430.8501	09.01.021	40	KG.22019.1.1	09.01.008	39
1671953	RK.02.052	33	001.260.1863	09.01.035	42	KG.23017.1.1	09.09.009	47
85102142	RK.02.053	30	001.260.3463	09.01.027	41	KG.23021.1.2	09.02.003	44
1348878	RK.02.046	30	001.295.0307	09.01.001	38	KG.23030.0.2	09.01.022	41
271194	RK.02.051	33	001.295.0407	09.01.001	38	KG.2307.0.1	09.01.023	41
300194-2	RK.02.068	36	001.295.2906	09.01.004	38	KG.2394.1.12	09.01.042	43
5001843783	RK.02.063	33	001.295.3006	09.01.009	39	KG.2395.1.3	09.01.002	38
550453	RK.02.049	30	001.295.4006	09.01.038	43	KG.2395.1.7	09.01.004	38
550465	RK.02.050	30	001.295.4407	09.01.010	39	KG.250001.0.2	09.04.004	45
626731 AM	RK.02.071	37	001.295.5206	09.01.039	43	KG.250004.0.2	09.05.002	45
626733	RK.02.057	33	001.295.5306	09.02.003	44	KG.2595.1.4	09.03.007	44
81.30725.6061	RK.02.073	32	001.295.6006	09.01.002	38	KG.2602.1.1	09.01.019	40
81.30725.6090	RK.02.075	33	001.295.7406	09.01.008	39	KG.2604.1.1	09.01.009	39
970.051.903.2	RK.02.005	9	001.295.9106	09.01.014	39	KG.26703.1.1	09.01.044	43
970.051.904.2	RK.02.001	7	001.295.9506	09.01.007	38	KG.28012.0.1	09.02.006	44
970.051.905.2	RK.02.003	7	001.295.9606	09.01.039	43	KG.28014.1.1	09.02.002	44
970.051.906.2	RK.02.002	27	001.295.9607	09.01.005	38	KG.28019.4.1	09.01.029	41
970.051.907.2	RK.02.030	12	001.430.6001	09.01.011	39	KG.3106.0.1	09.09.001	47
970.051.909.2	RK.02.011	12	001.430.6801	09.01.011	39	KG.3401.0.1	09.01.032	42
970.051.910.2	RK.02.004	9	001.430.7901	09.01.020	40	KG.3401.0.2	09.01.031	42
970.051.911.2	RK.02.006	27	002.260.0663	09.01.035	42	KN.25020B1	09.01.036	42
970.051.916.2	RK.02.010	10	002.295.0707	09.01.040	43	KN.28013.A.1	09.06.004	46
970.051.917.2	RK.02.007	10	002.295.1006	09.01.026	41	KN.28014C1	09.06.002	46
970.051.919.2	RK.02.026	11	002.430.1401	09.09.003	47	KN.28022.0.1	09.01.005	38
970.051.943.2	RK.02.014	26	002.430.4101	09.09.003	47	KN.28027A1	09.01.040	43
970.051.944.2	RK.02.009	11	007.420.2118	09.01.025	41	KN.3406E66	09.01.043	43
970.051.945.2	RK.02.032	11	096392	09.04.004	45	KN.38017.3.5	09.01.033	42
970.051.946.2	RK.02.042	15	1348733	09.04.005	45	KN.38017.3.6	09.01.034	42
970.051.948.2	RK.02.041	17	1348734	09.04.002	44	KN.380532	09.01.010	39
970.051.949.2	RK.02.013	13	1348735	09.04.003	44	N24802C1	09.01.025	41
970.051.950.2	RK.02.012	27	1355979	09.01.034	42			
970.051.952.2	RK.02.015	25	1361136	09.05.002	45			
970.051.954.2	RK.02.008	28	1506121	09.01.033	42			
970.051.957.2	RK.02.044	17	1628218	09.02.006	44			
970.051.961.2	RK.02.029	13	1669488	09.02.002	44			
970.051.967.2	RK.02.037	22	323760AM	09.04.005	45			
970.051.971.2	RK.02.048	25	355973	09.03.007	44			
970.051.974.2	RK.02.016	29	42037645	09.01.036	42			
970.051.975.2	RK.02.031	28	623104AM	09.07.001	46			
970.051.984.2	RK.02.043	29	623105AM	09.07.002	46			
973.051.973.2	RK.02.059	27	623106AM	09.07.003	46			
AMPB893	RK.02.066	35	625536AM	09.05.010	45			
APGA/29069	RK.02.017	29	625826AM	09.04.006	45			
FBU9623	RK.02.067	35	626159AM	09.07.004	46			
I 83345 / 008	RK.02.019	1	626169AM	09.05.010	45			
I 88094 / 0051	RK.02.020	1	626597AM	09.01.027	41			
I 93581 / 0051	RK.02.018	1	626761AM	09.04.002	44			
II 14195008	RK.02.025	7	626762AM	09.04.003	44			
II 17767 / 0051	RK.02.023	2	627233AM	09.05.001	45			
II 31783 / 008	RK.02.022	1	81.30715.6051	09.01.032	42			
II 35696/008	RK.02.036	2	81.30715.6119	09.01.023	41			
			81.30715.6135	09.01.022	41			
			81.30716.6020	09.06.004	46			
			81.30716.6043	09.01.012	39			
			81.30716.6044	09.01.015	40			
			81.30716.6082	09.06.002	46			
			8172824	09.01.029	41			
			9K1591	09.09.004	47			

CLUTCH SERVOS and REPAIR KITS / DEBRİYAJ ALT MERKEZLERİ ve TAMİR TAKIMLARI

REFERANCE NO	YUMAK NO	PAGE NO	REFERANCE NO	YUMAK NO	PAGE NO	REFERANCE NO	YUMAK NO	PAGE NO
626397	RK.02.069	36	000.260.6357	09.01.006	38	ACHD274	09.04.006	45
628305	RK.02.040	31	000.295.6706	09.01.031	42	FD 2704	09.09.006	47
1291857	RK.02.065	35	000.295.8307	09.01.017	40	KG.19046.1.2	09.01.038	43
1443525	RK.02.047	34	000.295.8706	09.01.016	40	KG.20001.0.8	09.01.014	39
1484715	RK.02.045	30	000.430.8501	09.01.021	40	KG.22019.1.1	09.01.008	39
1671953	RK.02.052	33	001.260.1863	09.01.035	42	KG.23017.1.1	09.09.009	47
85102142	RK.02.053	30	001.260.3463	09.01.027	41	KG.23021.1.2	09.02.003	44
1348878	RK.02.046	30	001.295.0307	09.01.001	38	KG.23030.0.2	09.01.022	41
271194	RK.02.051	33	001.295.0407	09.01.001	38	KG.2307.0.1	09.01.023	41
300194-2	RK.02.068	36	001.295.2906	09.01.004	38	KG.2394.1.12	09.01.042	43
5001843783	RK.02.063	33	001.295.3006	09.01.009	39	KG.2395.1.3	09.01.002	38
550453	RK.02.049	30	001.295.4006	09.01.038	43	KG.2395.1.7	09.01.004	38
550465	RK.02.050	30	001.295.4407	09.01.010	39	KG.250001.0.2	09.04.004	45
626731 AM	RK.02.071	37	001.295.5206	09.01.039	43	KG.250004.0.2	09.05.002	45
626733	RK.02.057	33	001.295.5306	09.02.003	44	KG.2595.1.4	09.03.007	44
81.30725.6061	RK.02.073	32	001.295.6006	09.01.002	38	KG.2602.1.1	09.01.019	40
81.30725.6090	RK.02.075	33	001.295.7406	09.01.008	39	KG.2604.1.1	09.01.009	39
970.051.903.2	RK.02.005	9	001.295.9106	09.01.014	39	KG.26703.1.1	09.01.044	43
970.051.904.2	RK.02.001	7	001.295.9506	09.01.007	38	KG.28012.0.1	09.02.006	44
970.051.905.2	RK.02.003	7	001.295.9606	09.01.039	43	KG.28014.1.1	09.02.002	44
970.051.906.2	RK.02.002	27	001.295.9607	09.01.005	38	KG.28019.4.1	09.01.029	41
970.051.907.2	RK.02.030	12	001.430.6001	09.01.011	39	KG.3106.0.1	09.09.001	47
970.051.909.2	RK.02.011	12	001.430.6801	09.01.011	39	KG.3401.0.1	09.01.032	42
970.051.910.2	RK.02.004	9	001.430.7901	09.01.020	40	KG.3401.0.2	09.01.031	42
970.051.911.2	RK.02.006	27	002.260.0663	09.01.035	42	KN.25020B1	09.01.036	42
970.051.916.2	RK.02.010	10	002.295.0707	09.01.040	43	KN.28013.A.1	09.06.004	46
970.051.917.2	RK.02.007	10	002.295.1006	09.01.026	41	KN.28014C1	09.06.002	46
970.051.919.2	RK.02.026	11	002.430.1401	09.09.003	47	KN.28022.0.1	09.01.005	38
970.051.943.2	RK.02.014	26	002.430.4101	09.09.003	47	KN.28027A1	09.01.040	43
970.051.944.2	RK.02.009	11	007.420.2118	09.01.025	41	KN.3406E66	09.01.043	43
970.051.945.2	RK.02.032	11	096392	09.04.004	45	KN.38017.3.5	09.01.033	42
970.051.946.2	RK.02.042	15	1348733	09.04.005	45	KN.38017.3.6	09.01.034	42
970.051.948.2	RK.02.041	17	1348734	09.04.002	44	KN.380532	09.01.010	39
970.051.949.2	RK.02.013	13	1348735	09.04.003	44	N24802C1	09.01.025	41
970.051.950.2	RK.02.012	27	1355979	09.01.034	42			
970.051.952.2	RK.02.015	25	1361136	09.05.002	45			
970.051.954.2	RK.02.008	28	1506121	09.01.033	42			
970.051.957.2	RK.02.044	17	1628218	09.02.006	44			
970.051.961.2	RK.02.029	13	1669488	09.02.002	44			
970.051.967.2	RK.02.037	22	323760AM	09.04.005	45			
970.051.971.2	RK.02.048	25	355973	09.03.007	44			
970.051.974.2	RK.02.016	29	42037645	09.01.036	42			
970.051.975.2	RK.02.031	28	623104AM	09.07.001	46			
970.051.984.2	RK.02.043	29	623105AM	09.07.002	46			
973.051.973.2	RK.02.059	27	623106AM	09.07.003	46			
AMPB893	RK.02.066	35	625536AM	09.05.010	45			
APGA/29069	RK.02.017	29	625826AM	09.04.006	45			
FBU9623	RK.02.067	35	626159AM	09.07.004	46			
I 83345 / 008	RK.02.019	1	626169AM	09.05.010	45			
I 88094 / 0051	RK.02.020	1	626597AM	09.01.027	41			
I 93581 / 0051	RK.02.018	1	626761AM	09.04.002	44			
II 14195008	RK.02.025	7	626762AM	09.04.003	44			
II 17767 / 0051	RK.02.023	2	627233AM	09.05.001	45			
II 31783 / 008	RK.02.022	1	81.30715.6051	09.01.032	42			
II 35696/008	RK.02.036	2	81.30715.6119	09.01.023	41			
			81.30715.6135	09.01.022	41			
			81.30716.6020	09.06.004	46			
			81.30716.6043	09.01.012	39			
			81.30716.6044	09.01.015	40			
			81.30716.6082	09.06.002	46			
			8172824	09.01.029	41			
			9K1591	09.09.004	47			

CLUTCH SERVOS

	02.01.001
	VG 3200 I 93581

	02.01.002
	VG 3204 I 93582 0659807 637208220 637208440

	02.01.003
	VG 3208 I 88094 81.30725.6031 81.30725.6032 81.30725.6033

	02.01.004
	VG 3229 II 141794 81.30725.6051 81.30725.6053

	02.01.005
	VG 3261 II 31733 II 17464 81.30725.6065

REPAIR KITS

RK.02.018	
I 93581 / 0051	

RK.02.019	
I 83345 / 008	

RK.02.020	
I 88094 / 0051	

RK.02.021	
II 141794	

RK.02.022	
II 31783 / 008	

CLUTCH SERVOS

	02.01.006
	VG 3262 I 17767

	02.01.008
	VG 3264 II 35696

	02.01.010
	VG 3213 I 92489

	02.01.011
	VG 3228 II 37933

	02.01.012
	VG 3265 II 36373

REPAIR KITS

RK.02.023	
II 17767 / 0051	

RK.02.036	
II 35696 / 008	

RK.02.020	
I 88094 / 0051	

RK.02.021	

RK.02.019	
I 83345 / 008	

CLUTCH SERVOS

	02.01.013
	VG 3267
	II 36377

	02.01.014
	VG 3268
	II 37933

	02.01.015
	VG 3269
	II 36379

	02.01.016
	VG 3275
	II 37950

	02.01.017
	VG 3276
	II 40096F

REPAIR KITS

RK.02.019	
I 83345 / 008	

RK.02.020	
I 88094 / 0051	

RK.02.036	
II 35696 / 008	

RK.02.020	
I 88094 / 0051	

RK.02.022	
II 31783 / 008	

CLUTCH SERVOS

REPAIR KITS

	02.01.018
	VG 3238 II 19612

RK.02.020	
I 88094 / 0051	

	02.01.019
	VG 3285 K0001071

RK.02.018	
I 93581 / 0051	

	02.01.021
	VG 3239 II 17770

RK.02.020	
I 88094 / 0051	

	02.01.022
	VG 3283 K000411

RK.02.020	
I 88094 / 0051	

	02.01.023
	VG 3284 K000511

RK.02.020	
I 88094 / 0051	

CLUTCH SERVOS

	02.01.024
	VG 3221 98420498

	02.01.025
	VG 3288

	02.01.026
	VG 3289

	02.01.027
	VG 3277

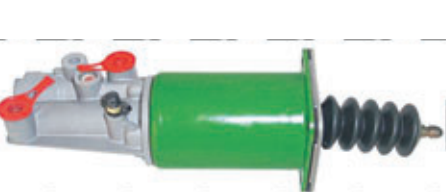
	02.01.028
	VG 3278

REPAIR KITS

RK.02.036	
II 35696 / 008	

RK.02.036	
II 35696 / 008	

RK.02.036	
II 35696 / 008	

RK.02.018	
I 93581 / 0051	

RK.02.019	
I 83345 / 008	

CLUTCH SERVOS

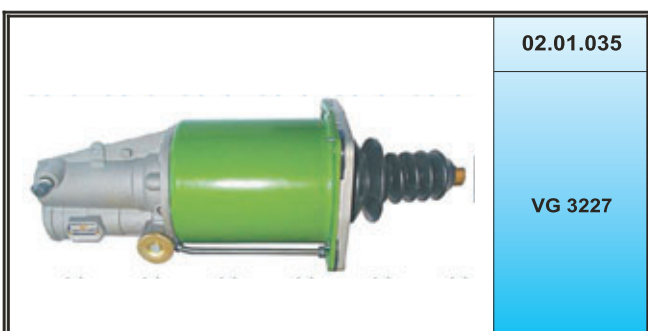
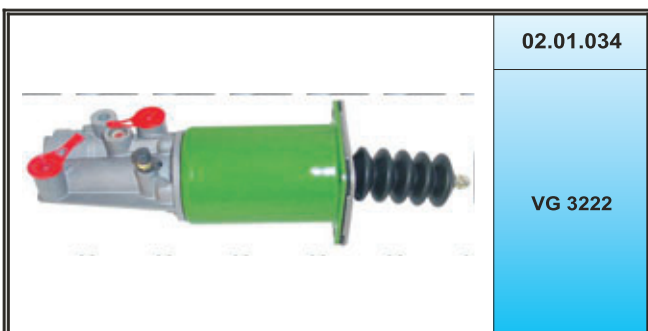
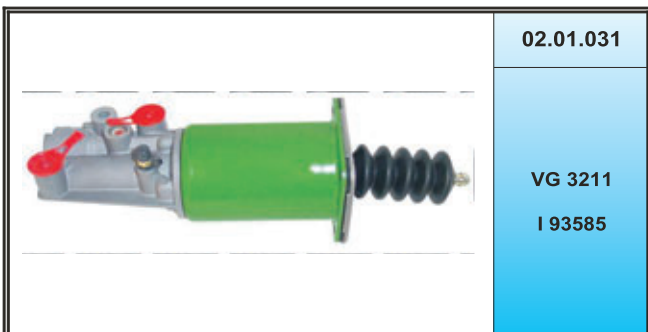
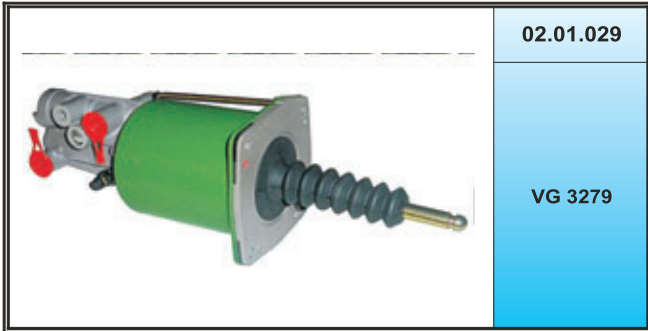

REPAIR KITS





CLUTCH SERVOS

	02.01.037
	VG 3234

	RK.02.034
FOR VG 3304 VG 3306	

	02.02.001
	970.051.102.0 699.295.0018 658882 624993 262077 4776623 42064599

	02.02.002
	970.051.107.0 1518242 343362 345362

	02.02.003
	970.051.111.0 81.30725.6014 81.30725.6026 81.30725.6027 81.30725.9026

REPAIR KITS

RK.02.018	
I 93581 / 0051	

RK.02.025	
II 14195 / 008 FOR VG 3361 000.295.1518	

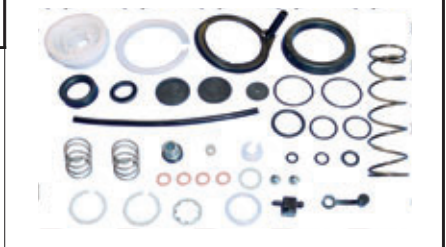
RK.02.080		
02.272		RK.02.001

RK.02.082		
02.272		RK.02.002

RK.02.084		
02.273		RK.02.003

CLUTCH SERVOS

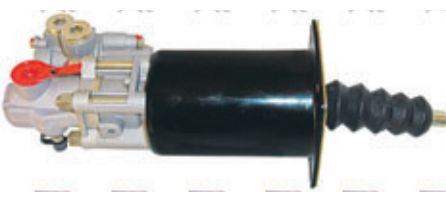
	02.02.004
	970.051.114.0 659807 85.30001.9892 500362256 42037229 72037766 2477724

	02.02.005
	970.051.124.0 1518244 5001136770 5000787875 503135313

	02.02.006
	970.051.126.0 1518245 42037229 5000815689

	02.02.007
	970.051.127.0 1519273 04791101 040320100

	02.02.008
	970.051.128.0 1518246 001.295.5607

REPAIR KITS

RK.02.081	
02.277	
RK.02.001	970.051.904.2

RK.02.082	
02.272	
RK.02.002	970.051.906.2

RK.02.081	
02.277	
RK.02.001	970.051.904.2

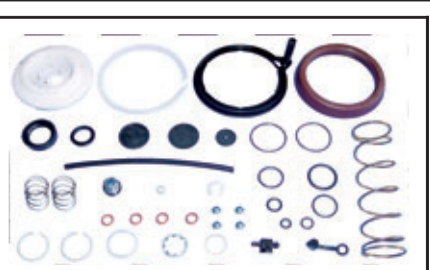
RK.02.083	
02.277	
RK.02.002	970.051.906.2

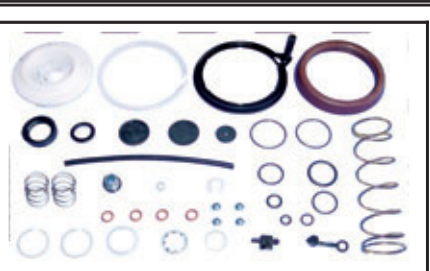
RK.02.083	
02.277	
RK.02.002	970.051.906.2

CLUTCH SERVOS

	02.02.009
	970.051.129.0 0281009 286295 8.285.280.000

	02.02.010
	970.051.131.0 1518247 001.295.3101 001.295.6707

	02.02.011
	970.051.132.0 1518248 1197265

	02.02.012
	970.051.135.0

	02.02.013
	970.051.137.0 1518249 000.295.0018

REPAIR KITS

RK.02.086	
02.273 RK.02.004 970.051.910.2	

RK.02.005	
970.051.903.2	

RK.02.089	
02.273 RK.02.006 970.051.911.2	

RK.02.086	
02.273 RK.02.004 970.051.910.2	

RK.02.087	
02.276 RK.02.004 970.051.910.2	

CLUTCH SERVOS

	02.02.009
	970.051.129.0 0281009 286295 8.285.280.000

	02.02.010
	970.051.131.0 1518247 001.295.3101 001.295.6707

	02.02.011
	970.051.132.0 1518248 1197265

	02.02.012
	970.051.135.0

	02.02.013
	970.051.137.0 1518249 000.295.0018

REPAIR KITS

RK.02.086	
02.273 RK.02.004 970.051.910.2	

RK.02.005	
970.051.903.2	

RK.02.089	
02.273 RK.02.006 970.051.911.2	

RK.02.086	
02.273 RK.02.004 970.051.910.2	

RK.02.087	
02.276 RK.02.004 970.051.910.2	

CLUTCH SERVOS

	02.02.019
	970.051.164.0 000.295.1318

	02.02.020
	970.051.165.0 042321100

	02.02.021
	970.051.176.0 1506459 11010080

	02.02.022
	970.051.182.0

	02.02.023
	970.051.204.0 1519280 42062535

REPAIR KITS

RK.02.118	
02.276	
RK.02.032	970.051.945.2

RK.02.095	
02.273	
RK.02.009	970.051.944.2

RK.02.099	
02.279	
RK.02.012	970.051.950.2

RK.02.082	
02.272	
RK.02.002	970.051.906.2

RK.02.111	
02.277	
RK.02.026	970.051.919.2

CLUTCH SERVOS

	02.02.024
	970.051.205.0 1519281

	02.02.025
	970.051.209.0 1518254 5000673126

	02.02.026
	970.051.210.0 0097539

	02.02.027
	970.051.307.0 81.30725.6064 81.30725.6065 81.30725.9064

	02.02.028
	970.051.401.0

REPAIR KITS

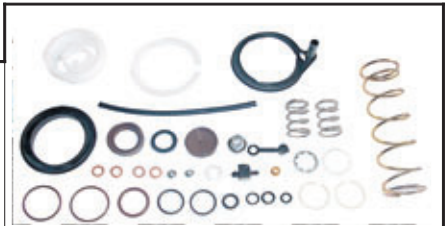
RK.02.113	
02.276	
RK.02.030	970.051.907.2

RK.02.097	
02.272	
RK.02.011	970.051.909.2

RK.02.085	
02.272	
RK.02.004	970.051.910.2

RK.02.102	
02.273	
RK.02.014	970.051.943.2

RK.02.125	
02.273	
RK.02.048	970.051.971.2

CLUTCH SERVOS

	02.02.029
	970.051.405.0 000.295.2818 000.254.0047

	02.02.030
	970.051.152.0 042320800 11010076

	02.02.031
	970.051.406.0 1505141 81.30725.6049 81.30725.6067

	02.02.032
	970.051.414.0 81.30725.6086 622500 1518255

	02.02.033
	970.051.431.0

REPAIR KITS

RK.02.100	
02.276	
RK.02.013	970.051.949.2

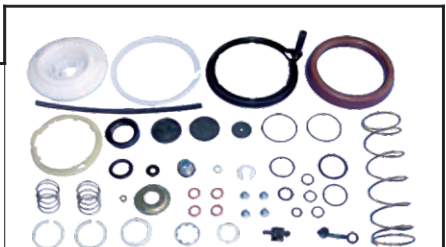
RK.02.089	
02.273	
RK.02.006	970.051.911.2

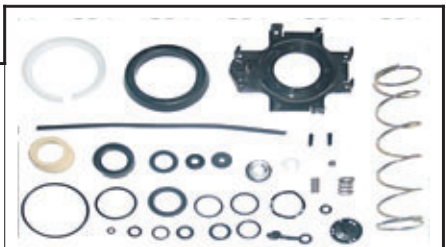
RK.02.107	
02.279	
RK.02.015	970.051.952.2

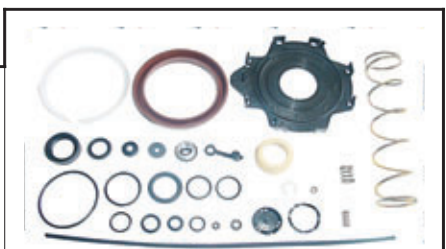
RK.02.112	
02.279	
RK.02.029	970.051.961.2

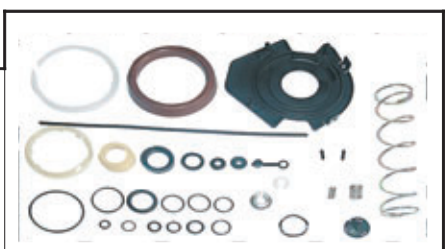
RK.02.109	
02.276	
RK.02.016	970.051.974.2

CLUTCH SERVOS

	02.02.034
	970.051.424.0 0.501.006.795

	02.02.035
	970.051.168.0

	02.02.037
	970.051.136.0 0390486

	02.02.040
	970.051.156.0

	02.02.041
	970.051.157.0 1518251 81.30725.6053 81.30725.6054

REPAIR KITS

RK.02.112	
02.279	
RK.02.029	970.051.961.2

RK.02.110	
02.273	
RK.02.026	970.051.919.2

RK.02.086	
02.273	
RK.02.004	970.051.910.2

RK.02.084	
02.273	
RK.02.003	970.051.905.2

RK.02.089	
02.273	
RK.02.006	970.051.911.2

CLUTCH SERVOS

	02.02.042
	970.051.161.0 000.295.1818

	02.02.043
	970.051.162.0 1505261 000.295.1018



	02.02.044
	970.051.166.0 970.051.179.0 384.295.7018



	02.02.045
	970.051.169.0 1515253 0281009 8.383.331.0008



	02.02.046
	970.051.170.0 970.051.173.0 81.30725.9062 81.30725.6062



REPAIR KITS

RK.02.010	
970.051.916.2 217 02 250	

RK.02.093	
 02.272	
RK.02.007	970.051.917.2

RK.02.121	
 02.272	
RK.02.042	970.051.946.2

RK.02.088	
 02.279	
RK.02.004	970.051.910.2

RK.02.110	
 02.273	
RK.02.026	970.051.919.2

CLUTCH SERVOS

	02.02.042
	970.051.161.0 000.295.1818

	02.02.043
	970.051.162.0 1505261 000.295.1018



	02.02.044
	970.051.166.0 970.051.179.0 384.295.7018



	02.02.045
	970.051.169.0 1515253 0281009 8.383.331.0008



	02.02.046
	970.051.170.0 970.051.173.0 81.30725.9062 81.30725.6062



REPAIR KITS

RK.02.010	
970.051.916.2 217 02 250	

RK.02.093	
 02.272	

RK.02.121	
 02.272	

RK.02.088	
 02.279	

RK.02.110	
 02.273	

CLUTCH SERVOS

	02.02.052
	970.051.183.0 970.051.177.0

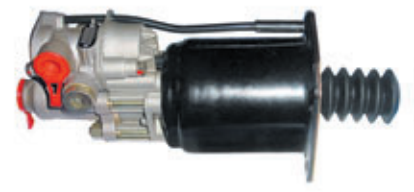
	02.02.054
	970.051.190.0 000.254.0147

	02.02.055
	970.051.217.0 1506462 81.60725.6060

	02.02.056
	970.051.218.0 1519283 5010244109

	02.02.057
	970.051.409.0 5010245221

REPAIR KITS

RK.02.088	
02.279	
RK.02.004	970.051.910.2

RK.02.093	
02.272	
RK.02.007	970.051.917.2

RK.02.130	
02.277	
RK.02.006	970.051.911.2

RK.02.120	
02.276	
RK.02.041	970.051.948.2

RK.02.124	
02.276	
RK.02.044	970.051.957.2

CLUTCH SERVOS

	02.02.058
	970.051.413.0

	02.02.059
	970.051.415.0
	970.051.438.0
	5010245868 5010452511

	02.02.060
	970.051.436.0
	1147633
	000.254.0347

	02.02.061
	970.051.437.0

	02.02.062
	970.051.423.0
	1506466
	501006570

REPAIR KITS

RK.02.104	
02.279	
RK.02.014	970.051.943.2

RK.02.124	
02.276	
RK.02.044	970.051.957.2

RK.02.116	
02.276	
RK.02.031	970.051.975.2

RK.02.112	
02.279	
RK.02.029	970.051.961.2

RK.02.112	
02.279	
RK.02.029	970.051.961.2

CLUTCH SERVOS

	02.02.063
	970.051.407.0

	02.02.064
	970.051.438.0 151.9286 504130066 5010452511

	02.02.066
	970.051.171.0 1519279 99434056 5010244123

	02.02.067
	970.051.179.0 970.051.166.0 384.295.7018

	02.02.068
	970.051.412.0 81.30725.6084

REPAIR KITS

RK.02.102	
02.273	
RK.02.014	970.051.943.2

RK.02.122	
02.276	
RK.02.043	970.051.984.2

RK.02.096	
02.276	
RK.02.009	970.051.944.2

RK.02.117	
02.272	
RK.02.032	970.051.945.2

RK.02.127	
02.279	
RK.02.048	970.051.971.2

CLUTCH SERVOS

	02.02.069
	970.051.402.0 5010244401

	02.02.071
	970.051.445.0 000.254.0847

	02.02.072
	970.051.410.0 5010245488

	02.02.073
	970.051.125.0

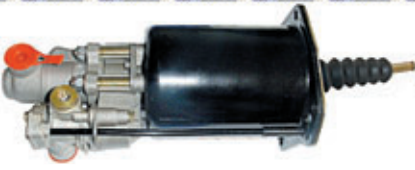
	02.02.074
	970.051.172.0

REPAIR KITS

RK.02.124	
02.276	
RK.02.044	970.051.957.2

RK.02.116	
02.276	
RK.02.031	970.051.975.2

RK.02.124	
02.276	
RK.02.044	970.051.957.2

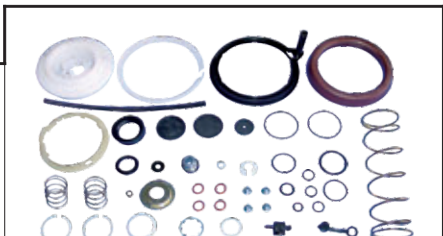
RK.02.090	
02.276	
RK.02.006	970.051.911.2

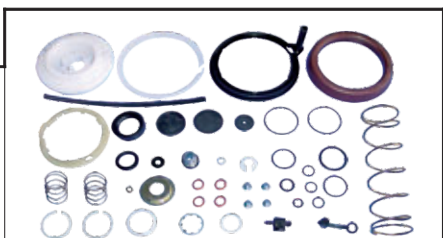
RK.02.092	
02.279	
RK.02.006	970.051.911.2

CLUTCH SERVOS

	02.02.075
	970.051.206.0 1506461

	02.02.076
	970.051.207.0

	02.02.077
	970.051.211.0

	02.02.078
	970.051.214.0 81.30725.6052

	02.02.079
	970.051.220.0 1506463 8.383.332.000B

REPAIR KITS

RK.02.114	
02.277	
RK.02.030	970.051.907.2

RK.02.098	
02.277	
RK.02.011	970.051.909.2

RK.02.086	
02.273	
RK.02.004	970.051.910.2

RK.02.098	
02.277	
RK.02.011	970.051.909.2

RK.02.115	
02.279	
RK.02.030	970.051.907.2

CLUTCH SERVOS

	02.02.080
	970.051.222.0 1519285 1261878

	02.02.081
	970.051.224.0

	02.02.082
	970.051.425.0

	02.02.083
	970.051.426.0

	02.02.084
	970.051.429.0 5010452429

REPAIR KITS

RK.02.119	
02.279	
RK.02.037	970.051.967.2

RK.02.119	
02.279	
RK.02.037	970.051.967.2

RK.02.127	
02.279	
RK.02.048	970.051.971.2

RK.02.105	
02.276	
RK.02.015	970.051.952.2

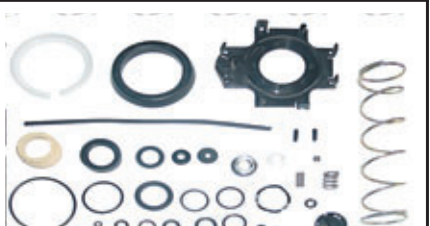
RK.02.107	
02.279	
RK.02.015	970.051.952.2

CLUTCH SERVOS

	02.02.085
	970.051.430.0 5010452472

	02.02.086
	970.051.432.0 81.30725.6108

	02.02.087
	970.051.433.0 000.295.3718

	02.02.088
	970.051.435.0

	02.02.089
	970.051.439.0

REPAIR KITS

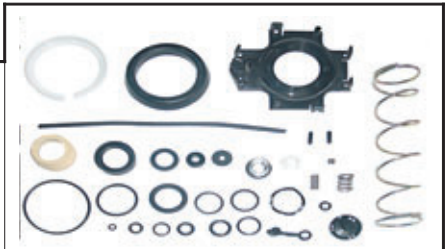
RK.02.107	
02.279	
RK.02.015	970.051.952.2

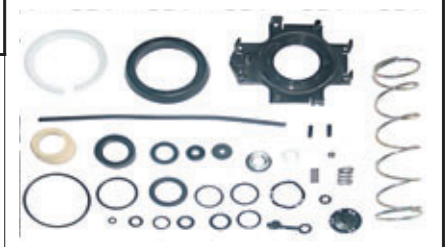
RK.02.107	
02.279	
RK.02.015	970.051.952.2

RK.02.109	
02.276	
RK.02.016	970.051.974.2

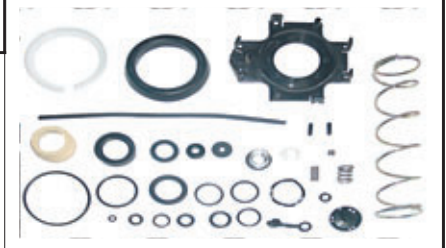
RK.02.107	
02.279	
RK.02.015	970.051.952.2

RK.02.123	
02.279	
RK.02.043	970.051.984.2

CLUTCH SERVOS

	02.02.090
	970.051.440.0

	02.02.091
	970.051.441.0 000.254.0247

	02.02.092
	970.051.443.0 000.254.0747

	02.02.093
	970.051.444.0

	02.02.094
	970.051.446.0 81.30725.6100

REPAIR KITS

RK.02.107	
02.279	
RK.02.015	970.051.952.2

RK.02.109	
02.276	
RK.02.016	970.051.974.2

RK.02.108	
02.272	
RK.02.016	970.051.974.2

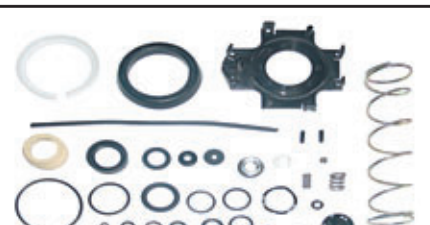
RK.02.105	
02.276	
RK.02.015	970.051.952.2

RK.02.127	
02.279	
RK.02.048	970.051.971.2

CLUTCH SERVOS

	02.02.095
	970.051.447.0 970.051.453.0

	02.02.096
	970.051.449.0

	02.02.097
	970.051.451.0

	02.02.098
	970.051.453.0 970.051.447.0

	02.02.099
	970.051.455.0

REPAIR KITS

RK.02.105	
02.276	
RK.02.015	970.051.952.2

RK.02.126	
02.276	
RK.02.048	970.051.971.2

RK.02.126	
02.276	
RK.02.015	970.051.952.2

RK.02.107	
02.279	
RK.02.015	970.051.952.2

RK.02.123	
02.279	
RK.02.043	970.051.984.2

CLUTCH SERVOS

	02.02.100
	970.051.457.0

	02.02.101
	970.051.461.0

	02.02.102
	970.051.462.0

	02.02.103
	970.051.463.0

	02.02.104
	970.051.464.0

REPAIR KITS

RK.02.103	
02.276	
RK.02.014	970.051.943.2

RK.02.101	
02.272	
RK.02.014	970.051.943.2

RK.02.101	
02.272	
RK.02.014	970.051.943.2

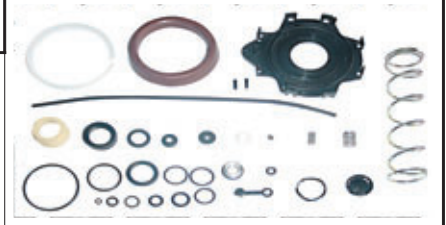
RK.02.104	
02.279	
RK.02.014	970.051.943.2

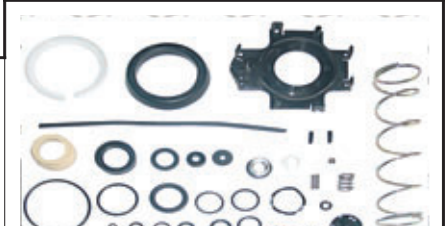
RK.02.107	
02.279	
RK.02.015	970.051.952.2

CLUTCH SERVOS

	02.02.105
	970.051.422.0

	02.02.106
	970.051.191.0

	02.02.107
	970.051.154.0

	02.02.108
	970.051.181.0

	02.02.109
	970.051.192.0

REPAIR KITS

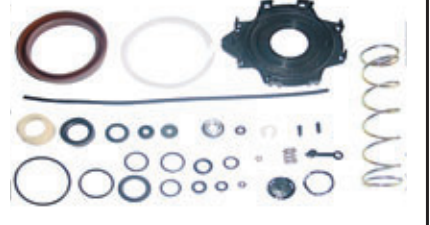
RK.02.128	
02.276	
RK.02.059	970.051.973.2

RK.02.082	
02.272	
RK.02.002	970.051.906.2

RK.02.092	
02.279	
RK.02.006	970.051.906.2

RK.02.129	
02.276	
RK.02.012	970.051.950.2

RK.02.082	
02.272	
RK.02.002	970.051.906.2

CLUTCH SERVOS

	02.02.110
	970.051.193.0

	02.02.111
	970.051.194.0

	02.02.112
	970.051.195.0

	02.02.113
	970.051.442.0

	02.02.114
	970.051.452.0

REPAIR KITS

RK.02.082	
02.272	
RK.02.002	970.051.906.2

RK.02.082	
02.272	
RK.02.002	970.051.906.2

RK.02.094	
02.276	
RK.02.008	970.051.954.2

RK.02.116	
02.276	
RK.02.031	970.051.975.2

RK.02.106	
02.277	
RK.02.015	970.051.952.2

CLUTCH SERVOS

	02.02.115
	970.051.454.0

	02.02.116
	970.051.459.0

	02.02.117
	970.051.466.0

	02.03.001
	APGA.1613

	02.03.002
	APGA.1605

REPAIR KITS

RK.02.109	
02.276	
RK.02.016	970.051.974.2

RK.02.123	
02.279	
RK.02.043	970.051.984.2

RK.02.127	
02.279	
RK.02.048	970.051.971.2

RK.02.017	
APGA / 29069	

RK.02.017	
APGA / 29069	

CLUTCH SERVOS

	02.04.001
	622107 360717

	02.04.002
	KA 625359 627692 AM 1421186

	02.04.004
	20524584 8171720 629276 628492

	02.04.005
	1443530 628275 1346864 622508

	02.04.006
	622190 374116

REPAIR KITS

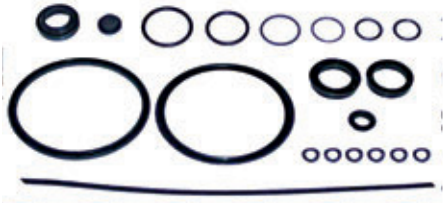
RK.02.049	
550453	

RK.02.045	
1484715	

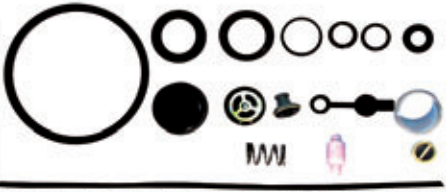
RK.02.053	
85102142	

RK.02.046	
1348878	

RK.02.050	
550465	

CLUTCH SERVOS

	02.04.007
	628036 1438606

	02.04.008
	628258 1443523

	02.04.009
	628259 1443522

	02.04.010
	628260 1443524

	02.04.011
	628447 1443533

REPAIR KITS

RK.02.046	
1348878	

RK.02.040	
1443527	

RK.02.040	
1443527	

RK.02.040	
1443527	

RK.02.046	
1348878	

CLUTCH SERVOS

	02.04.012
	628448 1450047

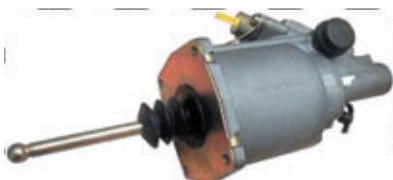
	02.04.013
	628449 1443529

	02.04.014
	625671 4200215000

	02.04.015
	625559 1318004040

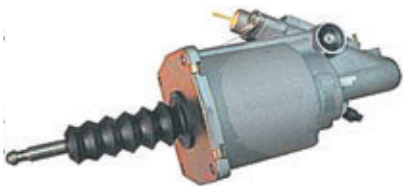
	02.04.016
	625586 81.30725.6051

REPAIR KITS

RK.02.040	
1443527	

RK.02.040	
1443527	

RK.02.046	
1348878	

RK.02.074	
17102250	

RK.02.073	
81.30725.6061	

CLUTCH SERVOS

	02.04.017
	628027 81.30725.6093

	02.04.018
	626162 5010244402

	02.04.019
	625524 5010.244.224

	02.05.002
	1668501 626639AM

	02.05.003
	626392AM 1655639

REPAIR KITS

RK.02.075	
81.30725.6090	

RK.02.063	
626729 5001 843 783	

RK.02.057	
626733 5001 843 797	

RK.02.052	
3093099 627366	

RK.02.051	
85102140 271194 626703	

CLUTCH SERVOS

	02.05.004
	628277 1346866 626708 626786

	02.05.005
	628276 626785 622501 626642

	02.05.006
	628493 629277

	02.05.007
	628450 1346863

	02.05.008
	1331770 622500 1443521

REPAIR KITS

RK.02.047	
1443525 628304 626788	

RK.02.047	
1443525 628304 626788	

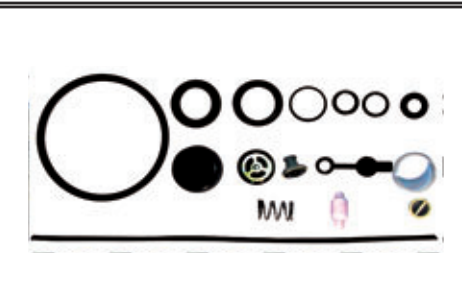
RK.02.053	
85102142	

RK.02.046	
1348878	

RK.02.050	
550465	

CLUTCH SERVOS

REPAIR KITS

	02.05.009
	622504 ACU 8944 1443520 1346865

RK.02.065	
1291857	

	02.05.010
	627498 624652 20524585 8171721 ATRA 460

RK.02.066	
AMPB 893	

	02.05.011
	ACHC 450 627499 1443531

RK.02.066	
AMPB 893	

	02.05.012
	627497 626104

RK.02.066	
AMPB 893	

	02.05.013
	625290 AXU 0132

RK.02.067	
FBU 9623	

CLUTCH SERVOS

REPAIR KITS

	02.05.014
	626693 622503

RK.02.068	
300194-2	

	02.05.015
	626397 626479

RK.02.069	
626397 626479	

	02.05.016
	622502 175.201.1622

RK.02.068	
300194-2	

	02.05.017
	627026 41700

RK.02.070	
627026 41700	

	02.05.018
	624410 520138

RK.02.068	
300194-2	

CLUTCH SERVOS

	02.05.019
	625384 5010.244.208

	02.05.020
	626853 5010.245.752

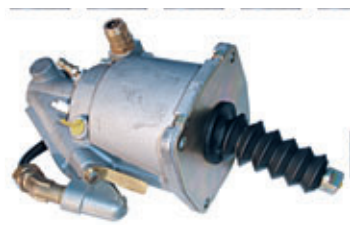
	02.05.021
	624199 1337966

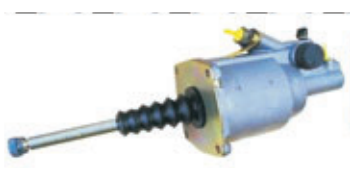
	02.05.022
	628494

	02.05.023
	629479

REPAIR KITS

RK.02.071	
5001 843 793 626731 AM	

RK.02.071	
5001 843 793 626731 AM	

RK.02.050	
550465	

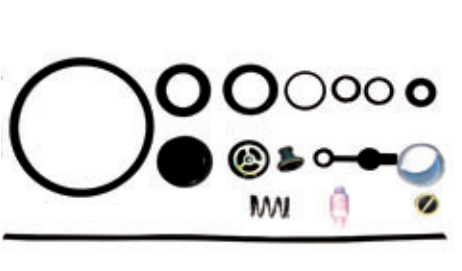
RK.02.053	
85102142	

RK.02.069	
626397 626479	

CLUTCH MASTER CYLINDERS

	09.01.001
	001.295.0307 001.295.0407

	09.01.002
	001.295.6006 KG.2395.1.3

	09.01.004
	001.295.2906 KG.2395.1.7

	09.01.005
	KN.28022.0.1 001.295.9607

	09.01.006
	000.260.6357

	09.01.007
	001.295.9506

REPAIR KITS

RK.09.012	
001.290.0911	

RK.09.017	

RK.09.014	

RK.09.015	

	

RK.09.039	

CLUTCH MASTER CYLINDERS

	09.01.008
	001.295.7406 KG.22019.1.1

	09.01.009
	001.295.3006 KG.2604.1.1

	09.01.010
	KN.3194C1 001.295.4407

	09.01.011
	001.430.6001 001.430.6801

	09.01.012
	81.30716.6043

	09.01.014
	001.295.9106 KG.20001.0.8

REPAIR KITS

RK.09.018	
-----------	---

RK.09.013	
-----------	---

RK.09.019	
-----------	--

RK.09.049	
-----------	---

RK.09.045	
-----------	---

RK.09.053	
-----------	--

CLUTCH MASTER CYLINDERS

	09.01.015
	81.30716.6044

	09.01.016
	000.295.8706

	09.01.017
	000.295.8307

	09.01.019
	KG.2602.1.1

	09.01.020
	001.430.7901

	09.01.021
	000.430.8501

REPAIR KITS

RK.09.046	
-----------	---

RK.09.047	
-----------	---

RK.09.055	
-----------	--

RK.09.056	
-----------	---

RK.09.057	
-----------	---

RK.09.058	
-----------	---

CLUTCH MASTER CYLINDERS

	09.01.022
	81.30715.6135 KG.23030.0.2

	09.01.023
	81.30715.6119 KG.23027.0.1

	09.01.025
	007.420.2118 N24802C1

	09.01.026
	002.295.1006 KG.20003.4.2

	09.01.027
	001.260.3463 626597AM

	09.01.029
	8172824 KG.28019.4.1

REPAIR KITS

RK.09.059	
-----------	---

RK.09.052	
-----------	---

RK.09.060	
-----------	--

RK.09.061	
-----------	---

RK.09.054	
-----------	---

--	--

CLUTCH MASTER CYLINDERS

REPAIR KITS

	09.01.031
	000.295.6706 KG.3401.0.2

RK.09.063	
-----------	---

	09.01.032
	81.30715.6051 KG.3401.0.1

RK.09.063	
-----------	---

	09.01.033
	KN.38017.3.5 1506121

--	--

	09.01.034
	KN.38017.3.6 1355979

--	--

	09.01.035
	002.260.0663 001.260.1863

RK.09.043	
-----------	---

	09.01.036
	KN.25020B1 42037645

RK.09.065	
-----------	---

CLUTCH MASTER CYLINDERS

REPAIR KITS

	09.01.038
	001.295.4006 KG.19046.1.2

RK.09.066	
-----------	---

	09.01.039
	001.295.5206 001.295.9606 KG.190072.0.1

RK.09.067	
-----------	---

	09.01.040
	002.295.0707 KN.28027A1

RK.09.068	
-----------	--

	09.01.042
	KG.2394.1.12

RK.09.069	
-----------	---

	09.01.043
	KN.3406E66

RK.09.070	
-----------	---

	09.01.044
	KG.26703.1.1

RK.09.071	
-----------	---

CLUTCH MASTER CYLINDERS

REPAIR KITS

	09.02.002
	KG.28014.1.1 1669488

RK.09.016	
-----------	---

	09.02.003
	KG.23021.1.2 001.295.5306

RK.09.023	
-----------	---

	09.02.006
	KG.28012.0.1 1628218

RK.09.073	
-----------	--

	09.03.007
	KG.2595.1.4 355973

RK.09.009	
-----------	---

	09.04.002
	626761AM 1348734

RK.09.037	
-----------	---

	09.04.003
	626762AM 1348735

RK.09.036	
-----------	---

CLUTCH MASTER CYLINDERS

REPAIR KITS

	09.04.004
	KG.250001.0.2 096392

RK.09.042	
-----------	---

	09.04.005
	323760AM 1348733

RK.09.072	
-----------	---

	09.04.006
	625826AM ACHD274

RK.09.075	
-----------	--

	09.05.001
	627233AM

RK.09.011	
-----------	---

	09.05.002
	1361136 KG.250004.0.2

RK.09.024	
-----------	---

	09.05.010
	626169AM 625536AM

--	--

CLUTCH MASTER CYLINDERS

	09.06.002
	81.30716.6082 KN.28014C1

	09.06.004
	81.30716.6020 KN.28013.A.1

	09.07.001
	623104AM Ø26

	09.07.002
	623105AM Ø28

	09.07.003
	623106AM Ø26

	09.07.004
	626159AM Ø28

REPAIR KITS

RK.09.081	
-----------	---

RK.09.082	
-----------	---

--	--

--	--

RK.09.031	
-----------	---

RK.09.032	
-----------	---



CLUTCH MASTER CYLINDERS





REPAIR KITS



UNLOADER VALVES AND REPAIR KITS

				
		RK.03.002		975.300.000.2
Yumak No	Refrence No	Description		Motor Type
03.01.001	975.300.110.0	With Tyre Inflator - Şişiricili	8.1 bar	Mercedes - Ikarus
03.01.002	975.300.112.0	With Tyre Inflator - Şişiricili	7.8 bar	Mercedes
03.01.003	975.300.013.0	Without Tyre Inflator - Şişiricisiz	7.3 bar	Volvo - Daf - Iveco
03.01.009	975.300.111.0	With Tyre Inflator - Şişiricili	7.3 bar	Mercedes - Steyr
03.01.013	975.300.095.0	With Tyre Inflator - Şişiricili	15 bar	Mercedes
03.01.014	975.300.551.0	Without Tyre Inflator - Şişiricisiz	8.5 bar	Renault - Van Hool
03.01.015	975.300.550.0	Without Tyre Inflator - Şişiricisiz	9.3 bar	Iveco - Man - Faun
03.01.016	975.300.502.0	With Tyre Inflator - Şişiricili	8.0 bar	Setra - Volvo - Iveco
03.01.017	975.300.156.0	With Tyre Inflator - Şişiricili	8.5 bar	Mercedes - Man
03.01.029	975.300.014.0	Without Tyre Inflator - Şişiricisiz	8.1 bar	Mercedes

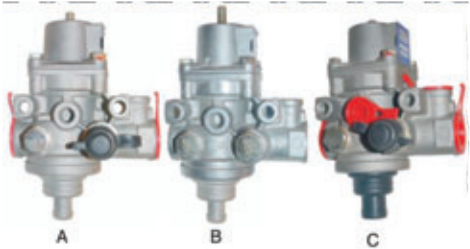
UNLOADER VALVES AND REPAIR KITS

				
		RK.03.001		1.487.010.165
Yumak No	Refrence No	Description		Motor Type
03.02.001	0.481.039.221	B	Without Tyre Inflator - Şişiricisiz	8.1 bar Mercedes - Steyr
03.02.002	0.481.039.209	C	With Tyre Inflator - Şişiricili	8.1 bar Mercedes - Grau
03.02.003	0.481.039.240	A	With Tyre Inflator - Şişiricili	8.5 bar Mercedes
03.02.004	0.481.039.210	A	With Tyre Inflator - Şişiricili	8.0 bar Renault
03.02.005	0.481.039.201	A	With Tyre Inflator - Şişiricili	8.1 bar Mercedes
03.02.006	0.481.039.213	C	With Tyre Inflator - Şişiricili	10 bar Kassbohrer-Grau
03.02.009	0.481.039.202	A	With Tyre Inflator - Şişiricili	7.3 bar Mercedes-Renault
03.02.010	0.481.039.218	A	With Tyre Inflator - Şişiricili	7.8 bar Iveco
03.02.011	0.481.039.222	B	Without Tyre Inflator - Şişiricisiz	12 bar Mercedes
03.02.012	0.481.039.234	C	With Tyre Inflator - Şişiricili	8.1 bar Kassbohrer
03.02.013	0.481.039.241	C	With Tyre Inflator - Şişiricili	8.5 bar Mercedes

UNLOADER VALVES AND REPAIR KITS

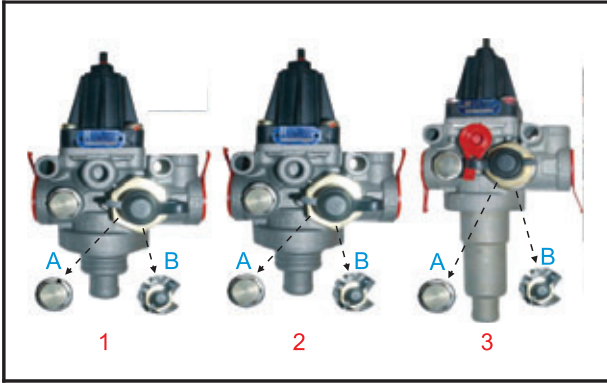

RK.03.003

975.303.001.2

Yumak No	Refence No	Description		Motor Type
03.01.005	975.303.474.0	1	B	With tyre inflator - Şişiricili 10 bar Daf - Nato Mercedes
03.01.006	975.303.504.0	1	B	With tyre inflator - Şişiricili 10 bar Man Mercedes
03.01.034	975.303.085.0	1	A	Without tyre inflator - Şişiricisiz 9,5 bar Mercedes
03.01.023	975.303.472.0	1	B	With tyre inflator - Şişiricili 8,0 bar Man Mercedes
03.01.031	975.303.541.0	1	B	With tyre inflator - Şişiricili 12 bar Mercedes
03.01.020	975.303.061.0	1	A	Without tyre inflator - Şişiricisiz 8,1 bar Daf-Man-Iveco Mercedes-Nato
03.01.021	975.303.072.0	1	B	With tyre inflator - Şişiricili 8,5 bar Daf-Man-Iveco Mercedes-Scania
03.01.004	975.303.473.0	2	B	With tyre inflator - Şişiricili 8.1 bar Volvo-Mercedes Iveco-Renault
03.01.007	975.303.081.0	2	A	Without tyre inflator - Şişiricisiz 9.5 bar Marelli-Mercedes Man-Renault
03.01.024	975.303.447.0	2	B	With tyre inflator - Şişiricili 7.3 bar Marelli-Mercedes Man-Renault
03.01.025	975.303.441.0	2	B	With tyre inflator - Şişiricili 7.8 bar Iveco-Liebherr Nato-Magirus
03.01.028	975.303.463.0	2	B	With tyre inflator = Şişiricili 8.5 bar Renault
03.01.022	975.303.082.0	2	A	Without tyre inflator - Şişiricisiz 9.8 bar Daf
03.01.032	975.303.120.0	2	A	Without tyre inflator - Şişiricisiz 11 bar Iveco-Marelli
03.01.033	975.303.469.0	2	B	With tyre inflator - Şişiricili 8,5 bar Mercedes-Renault
03.01.008	975.303.478.0	3	B	With tyre inflator - Şişiricili 8,1 bar Daf-Man-Iveco Scania-Volvo
03.01.018	975.303.084.0	3	A	Without tyre inflator - Şişiricisiz 9,5 bar Man-Iveco-Scania Mercedes-Renault
03.01.026	975.303.446.0	3	B	With tyre inflator - Şişiricili 7,8 bar Liebherr-Nato
03.01.027	975.303.140.0	3	A	Without tyre inflator - Şişiricisiz 12,5 bar Man
03.01.035	975.303.220.0	3	A	Without tyre inflator - Şişiricisiz 16 bar Iveco-Man

AIR DRYER VALVES AND REPAIR KITS

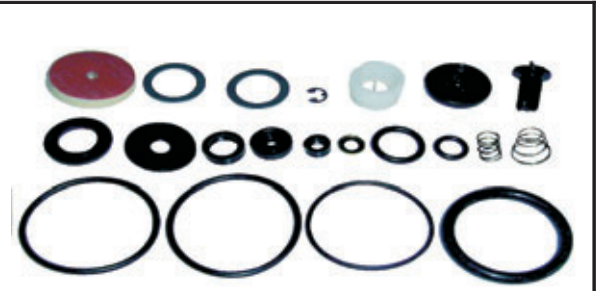

RK.03.006

432.410.002.2

Yumak No	Refence No	Description	Bar
03.03.005	432.410.000.0	24V	8.1 bar
03.03.048	432.410.003.0	12V	8.1 bar
03.03.049	432.410.004.0	24V	11.0 bar
03.03.033	432.410.005.0	-	10.0 bar
03.03.013	432.410.007.0	24V	8.5 bar
03.03.008	432.410.008.0	24V	11.8 bar
03.03.050	432.410.010.0	24V	9.3 bar
03.03.023	432.410.011.0	24V	12.2 bar
03.03.051	432.410.012.0	24V	9.3 bar
03.03.030	432.410.020.0	24V	9.5 bar
03.03.035	432.410.021.0	-	9.5 bar
03.03.027	432.410.022.0	24V	9.5 bar
03.03.015	432.410.023.0	-	11.0 bar
03.03.052	432.410.024.0	24V	9.5 bar
03.03.053	432.410.025.0	24V	9.5 bar
03.03.014	432.410.026.0	24V	9.8 bar
03.03.031	432.410.027.0	24V	10.0 bar
03.03.054	432.410.028.0	24V	8.1 bar
03.03.055	432.410.030.0	24V	16.5 bar
03.03.016	432.410.031.0	-	7.8 bar
03.03.056	432.410.033.0	-	12.5 bar
03.03.057	432.410.034.0	24V	12.5 bar
03.03.058	432.410.035.0	24V	11.0 bar
03.03.032	432.410.036.0	24V	7.3 bar
03.03.059	432.410.037.0	-	7.3 bar
03.03.060	432.410.038.0	-	12.5 bar
03.03.017	432.410.041.0	24V	8.5 bar
03.03.028	432.410.042.0	24V	8.5 bar
03.03.009	432.410.043.0	24V	9.5 bar
03.03.061	432.410.044.0	24V	16.5 bar

Yumak No	Refence No	Description	Bar
03.03.062	432.410.049.0	24V	9.0 bar
03.03.063	432.410.050.0	24V	8.1 bar
03.03.064	432.410.064.0	-	8.2 bar
03.03.065	432.410.066.0	-	8.5 bar
03.03.018	432.410.067.0	24V	8.5 bar
03.03.066	432.410.068.0	-	10.0 bar
03.03.029	432.410.069.0	24V	10.0 bar
03.03.067	432.410.073.0	-	11.0 bar
03.03.068	432.410.074.0	-	12.5 bar
03.03.069	432.410.075.0	24V	11.0 bar
03.03.070	432.410.076.0	24V	12.5 bar
03.03.071	432.410.078.0	-	8.5 bar
03.03.025	432.410.102.0	24V	8.1 bar
03.03.040	432.410.104.0	24V	8.1 bar
03.03.034	432.410.110.0	24V	12.5 bar
03.03.011	432.410.111.0	-	12.5 bar
03.03.036	432.410.112.0	24V	12.5 bar
03.03.012	432.410.113.0	-	12.5 bar
03.03.037	432.410.114.0	24V	8.5 bar
03.03.072	432.410.115.0	-	8.5 bar
03.03.073	432.410.116.0	24V	10.5 bar
03.03.007	432.410.117.0	-	10.5 bar
03.03.022	432.410.118.0	24V	8.8 bar
03.03.074	432.410.200.0	24V	8.1 bar
03.03.079	432.410.201.0	-	8.1 bar
03.03.075	432.410.202.0	-	8.1 bar
03.03.076	432.410.203.0	24V	8.5 bar
03.03.077	432.410.250.0	24V	10.0 bar
03.03.078	432.410.251.0	-	10.0 bar

AIR DRYER VALVES AND REPAIR KITS



Yumak No	Refence No	Description	Bar	Motor Type
03.03.004	432.421.000.0 000.431.7215 000.431.7915 110273401	24V - 100W	13 bar	Daimler - Daf Chrysler - Neoplan
03.03.006	432.421.002.0	WITHOUT HEATING	13 bar	Daimler - Daf Chrysler - Neoplan
03.03.020	432.421.007.0 001.431.0815 001.431.2115 1517977	24V - 100W	13 bar	Daimler - Daf Chrysler - Neoplan
03.03.021	432.421.008.0 000.431.0415 1517978	WITHOUT HEATING	13 bar	Daimler - Daf Chrysler - Neoplan
03.03.041	432.420.001.0 432.420.000.0	WITHOUT HEATING	13 bar	Daimler - Daf Chrysler - Neoplan

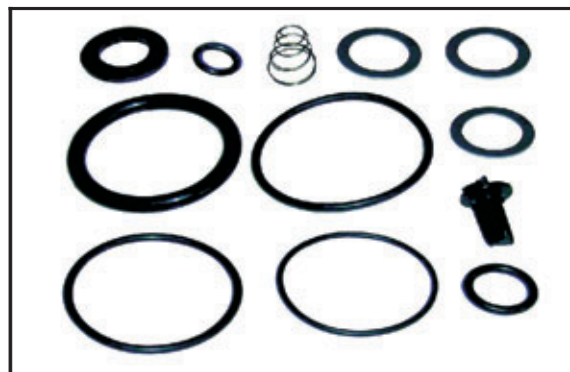

RK.03.005

432.410.000.2

AIR DRYER VALVES AND REPAIR KITS

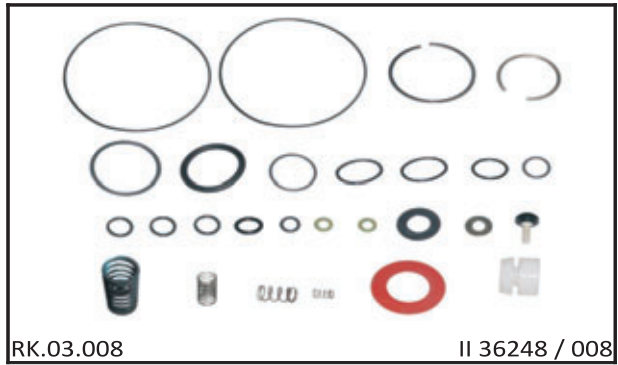

RK.03.008

II 36248 / 008

Yumak No	Refrence No	Description	Bar
03.04.001	LA8200	24 V	8,5 Bar
03.04.002	LA8201	24 V	10 Bar
03.04.024	LA8202	24 V	12 Bar
03.04.025	LA8203	-	8,5 Bar
03.04.026	LA8204	-	10 Bar
03.04.027	LA8205	-	12 Bar
03.04.003	LA8206	24 V	9,8 Bar
03.04.028	LA8207	-	9,5 Bar
03.04.029	LA8208	24 V	8,5 Bar
03.04.030	LA8209	-	10 Bar
03.04.031	LA8210	24 V	10 Bar
03.04.032	LA8211	-	12,5 Bar
03.04.033	LA8212	24 V	12,5 Bar
03.04.034	LA8219	-	11 Bar
03.04.004	LA8220	24 V	11 Bar
03.04.005	LA8221	-	12,5 Bar
03.04.006	LA8222	24 V	12,5 Bar
03.04.007	LA8223	24 V	8,4 Bar
03.04.035	LA8224	24 V	8,4 Bar
03.04.008	LA8225	24 V	8,1 Bar
03.04.036	LA8226	24 V	8,4 Bar
03.04.037	LA8227	24 V	10 Bar
03.04.038	LA8228	-	8,1 Bar
03.04.009	LA8229	-	9,5 Bar
03.04.039	LA8230	24 V	10 Bar
03.04.040	LA8231	-	7,8 Bar
03.04.041	LA8232	-	12,5 Bar
03.04.010	LA8233	24 V	12,5 Bar
03.04.011	LA8234	24 V	8,1 Bar
03.04.042	LA8235	-	10 Bar
03.04.043	LA8236	-	8,1 Bar
03.04.044	LA8237	24 V	8,1 Bar
03.04.045	LA8238	12 V	8,4 Bar
03.04.046	LA8239	YOK	7,35 Bar
03.04.047	LA8240	24 V	8,4 Bar

Yumak No	Refrence No	Description	Bar
03.04.012	LA8241	24 V	12,5 Bar
03.04.013	LA8242	24 V	11 Bar
03.04.014	LA8243	24 V	9,5 Bar
03.04.015	LA8244	24 V	7,8 Bar
03.04.016	LA8245	24 V	8,5 Bar
03.04.048	LA8247	24 V	9,5 Bar
03.04.049	LA8248	-	7,35 Bar
03.04.050	LA8249	24 V	8,5 Bar
03.04.051	LA8250	24 V	7,35 Bar
03.04.052	LA8251	-	7,35 Bar
03.04.053	LA8252	-	8,3 Bar
03.04.054	LA8253	-	8,1 Bar
03.04.055	LA8254	-	12,5 Bar
03.04.056	LA8255	24 V	12,5 Bar
03.04.057	LA8256	24 V	10 Bar
03.04.058	LA8257	24 V	8,1 Bar
03.04.059	LA8258	-	10 Bar
03.04.060	LA8259	24 V	8,3 Bar
03.04.061	LA8261	25 V	12,5 Bar
03.04.062	LA8263	-	9,8 Bar
03.04.063	LA8267	12 V	8,5 Bar
03.04.064	LA8268	12 V	10 Bar
03.04.065	LA8269	24 V	8,1 Bar
03.04.066	LA8270	24 V	10 Bar
03.04.017	LA8271	24 V	8,5 Bar
03.04.067	LA8273	24 V	12,5 Bar
03.04.068	LA8275	-	8,1 Bar
03.04.069	LA8280	12 V	8,5 Bar
03.04.070	LA8281	12 V	10 Bar
03.04.071	LA8282	12 V	12 Bar
03.04.072	LA8283	24 V	7,9 Bar
03.04.019	LA8284	24 V	9,8 Bar
03.04.073	LA8286	24 V	12 Bar
03.04.074	LA8288	24 V	12,5 Bar
03.04.020	LA8700	-	13 Bar

LEVELLING VALVES AND REPAIR KITS

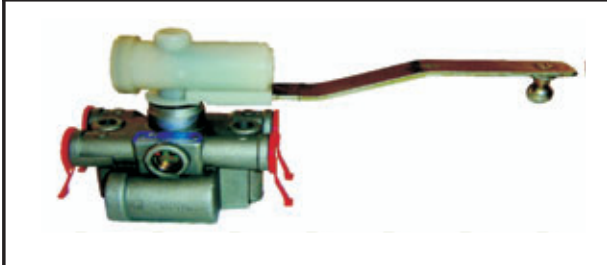

06.01.001	0.500.005.001	12 Bar
06.01.005	0.500.005.101	12 Bar



06.01.002	0.500.005.002	12 Bar
06.01.006	0.500.005.102	12 Bar



06.01.003	0.500.005.006	10 Bar
06.01.011	0.500.005.104	12 Bar

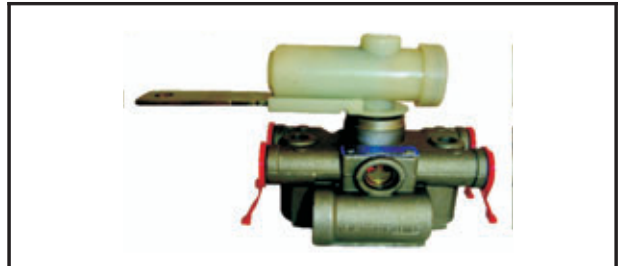

06.01.004	0.500.005.007	10 Bar
06.01.012	0.500.005.105	12 Bar



RK.06.001

1.507.010.007

LEVELLING VALVES AND REPAIR KITS

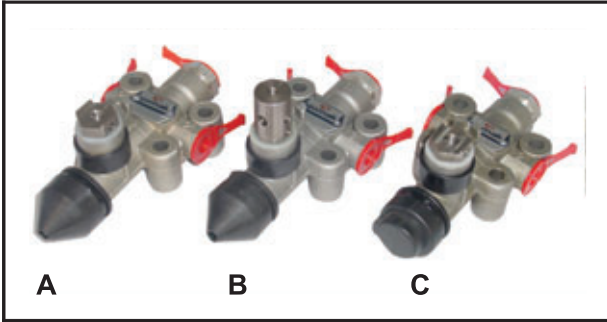

RK.06.004

I 755223

Yumak No	Refrence No	
06.02.001	SV 1294	A
06.02.002	SV 1307	B
06.02.003	SV 1310	A
06.02.008	SV 1260	A
06.02.010	SV 1278	A
06.02.011	SV 1361	A
06.02.013	SV 1412	A
06.02.014	SV 1468	C
06.02.015	SV 1411	A
06.02.035	SV 1271	A
06.02.039	SV 1339	A
06.02.040	SV 1340	A
06.02.046	SV 1433	A
06.02.054	SV 1288	C

Yumak No	Refrence No	
06.02.055	SV 1455	B
06.02.058	SV 1279	A
06.02.067	SV 1483	B
06.02.072	SV 1345	A
06.02.101	SV 1445	A
06.02.102	SV 1494	C
06.02.103	SV 1372	B
06.02.104	SV 1367	B
06.02.105	SV 1486	B
06.02.106	SV 1487	B
06.02.109	SV 1395	B

LEVELLING VALVES AND REPAIR KITS



RK.06.005

Yumak No	Refrence No	
06.02.004	SV 1295	
06.02.016	SV 1323	
06.02.017	SV 1399	
06.02.018	SV 1318	
06.02.019	SV 1321	
06.02.020	SV 1328	

Yumak No	Refrence No	
06.02.032	SV 1351	
06.02.066	SV 1434	
06.02.076	SV 1352	
06.02.107	SV 1432	
06.02.108	SV 1431	

LEVELLING VALVES AND REPAIR KITS

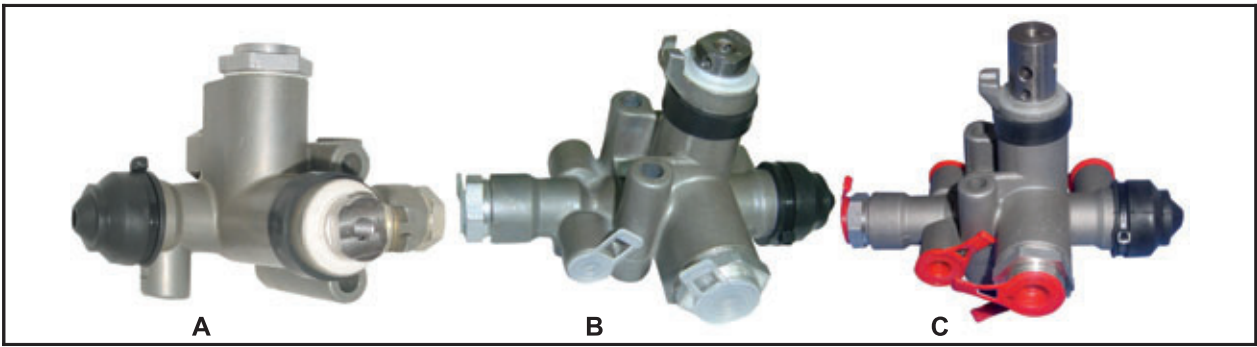

Yumak No	Refrence No	
06.02.005	SV 1281	B
06.02.007	SV 1280	A
06.02.021	SV 1381	A
06.02.022	SV 1419	A
06.02.023	SV 1329	A
06.02.024	SV 1330	A
06.02.025	SV 1370	A
06.02.026	SV 1377	A
06.02.027	SV 1378	A
06.02.028	SV 1284	B
06.02.029	SV 1287	B
06.02.030	SV 1301	B
06.02.031	SV 1303	B
06.02.033	SV 1363	B
06.02.034	SV 1325	A
06.02.052	SV 1409	B
06.02.056	SV 1410	C
06.02.057	SV 1298	B
06.02.065	SV 1299	A
06.02.077	SV 1442	A
06.02.078	SV 1425	A
06.02.079	SV 1426	A

Yumak No	Refrence No	
06.02.080	SV 1380	A
06.02.081	SV 1418	C
06.02.082	SV 1440	C
06.02.083	SV 1447	C
06.02.084	SV 1466	C
06.02.085	SV 1465	C
06.02.086	SV 1403	A
06.02.087	SV 1404	A
06.02.088	SV 1416	A
06.02.089	SV 1417	A
06.02.090	SV 1421	A
06.02.091	SV 1422	A
06.02.092	SV 1427	A
06.02.093	SV 1428	A
06.02.094	SV 1429	A
06.02.095	SV 1430	A
06.02.096	SV 1435	A
06.02.097	SV 1436	A
06.02.098	SV 1437	A
06.02.099	SV 1441	A
06.02.100	SV 1443	A



RK.06.006

I 74651

LEVELLING VALVES AND REPAIR KITS

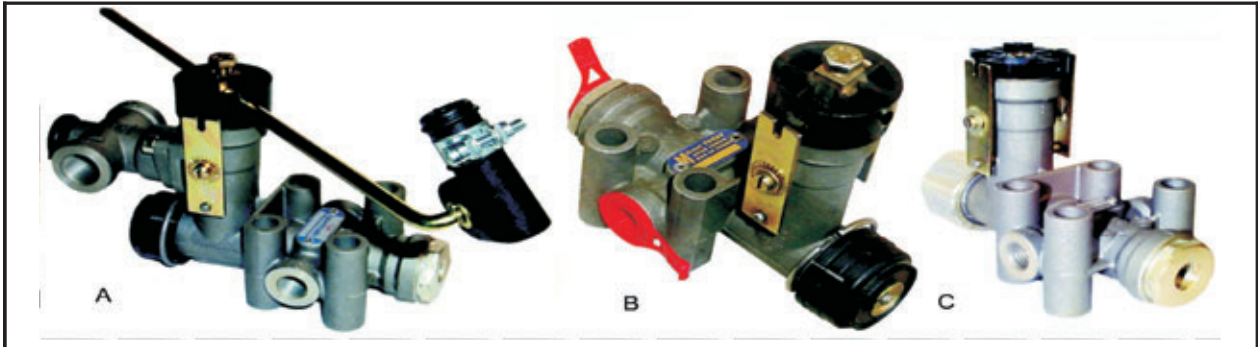

Yumak No	Refence No	Description	
06.04.002	464.006.002.0	B	13 Bar
06.04.003	464.006.004.0	B	13 Bar
06.04.004	464.006.000.0	C	13 Bar
06.04.007	464.006.100.0	A	15 Bar
06.04.008	464.006.001.0	B	13 Bar
06.04.011	464.006.005.0	B	13 Bar
06.04.012	464.006.006.0	B	13 Bar
06.04.013	464.006.007.0	B	13 Bar
06.04.014	464.006.009.0	B	13 Bar
06.04.015	464.006.012.0	B	13 Bar



RK.06.003

464.006.000.2

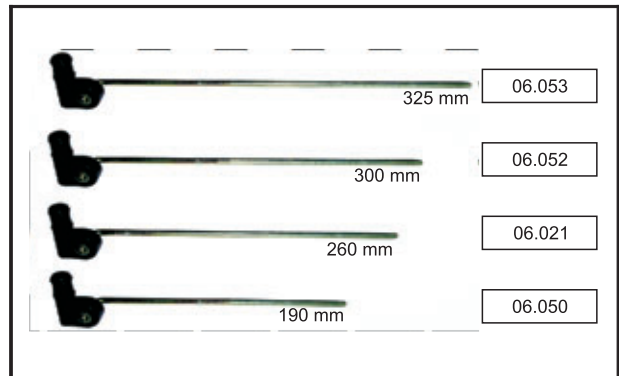

CIRCUIT PROTECTION VALVES AND REPAIR KITS



RK.05.001

934.702.004.2

Yumak No	Reference No	Description	Motor Type
05.01.001	934.702.300.0	MAX 20 Bar	Mercedes
05.01.002	934.702.381.0	MAX 20 Bar	Scania
05.01.005	934.702.042.0	MAX 10 Bar	Volvo
05.01.006	934.702.302.0	MAX 20 Bar	Iveco
05.01.008	934.702.110.0	MAX 20 Bar	Renault
05.01.010	934.702.000.0	MAX 10 Bar	Daf
05.01.011	934.702.002.0	MAX 20 Bar	Daf
05.01.012	934.702.005.0	MAX 10 Bar	Iveco
05.01.013	934.702.040.0	MAX 10 Bar	Volvo
05.01.014	934.702.041.0	MAX 10 Bar	Man
05.01.015	934.702.045.0	MAX 10 Bar	Volvo
05.01.016	934.702.047.0	MAX 10 Bar	Volvo
05.01.017	934.702.082.0	MAX 20 Bar	Renault
05.01.018	934.702.100.0	MAX 10 Bar	Volvo
05.01.019	934.702.320.0	MAX 20 Bar	Mercedes
05.01.020	934.702.322.0	MAX 20 Bar	Man
05.01.021	934.701.101.0	MAX 20 Bar	Daf

CIRCUIT PROTECTION VALVES AND REPAIR KITS

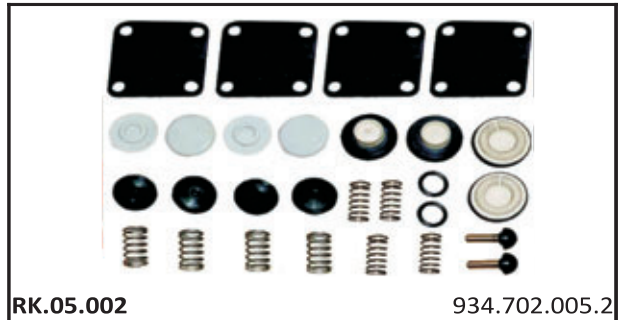

RK.05.002

934.702.005.2

Yumak No	Reference No	Description	Motor Type
05.01.003	934.702.221.0	MAX 20 Bar	Mercedes
05.01.004	934.702.210.0	MAX 10 Bar	Mercedes
05.01.022	934.702.220.0	MAX 20 Bar	Mercedes
05.01.023	934.702.223.0	MAX 20 Bar	Man
05.01.024	934.702.240.0	MAX 10 Bar	Man

CIRCUIT PROTECTION VALVES AND REPAIR KITS

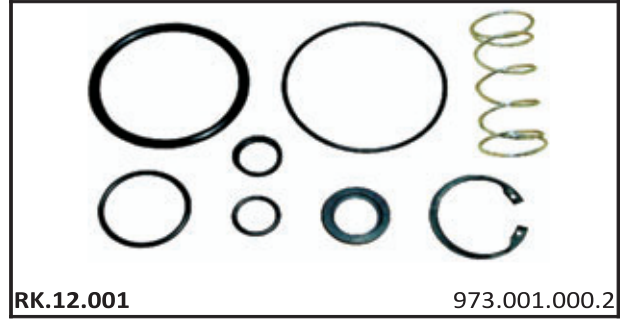

Yumak No	Reference No	Description	Motor Type
12.01.001	973.001.020.0	MAX 10 Bar	Mercedes - Volvo - Bmc
12.01.002	973.001.010.0	MAX 8 Bar	Man - Iveco - Setra
12.01.013	973.001.016.0	MAX 8 Bar	Mercedes
12.01.014	973.001.210.0	MAX 10 Bar	Daf
12.01.015	973.001.012.0	MAX 8 Bar	Renault - Man - Iveco - Bmc
12.01.016	973.001.014.0	MAX 8 Bar	Iveco
12.01.017	973.001.220.0	MAX 10 Bar	Mercedes - Bmc - Setra

CIRCUIT PROTECTION VALVES AND REPAIR KITS



Yumak No	Reference No	Description	Motor Type
12.01.005	973.001.221.0	MAX 10 Bar	Daf - Man - Neoplan
12.01.004	973.001.120.0	MAX 10 Bar	Man - Mercedes
12.01.018	973.001.021.0	MAX 10 Bar	Daf - Neoplan - Mercedes

CIRCUIT PROTECTION VALVES AND REPAIR KITS



Yumak No	Reference No	Description	Motor Type
12.01.011	973.011.000.0	MAX 10 Bar	Iveco - Nato - Faun
12.01.012	973.011.001.0	MAX 10 Bar	Man - Mercedes

OTHER PRODUCTS

	03.06.002
	932.400.001.0
	AIR DRYER VALVE

	03.06.003
	932.400.006.0
	AIR DRYER VALVE

	03.06.004
	932.500.006.0
	AIR DRYER VALVE

	05.01.031
	934.714.010.0
	CIRCUIT PROTECTION VALVE

	05.01.032
	934.714.152.0
	CIRCUIT PROTECTION VALVE

	05.02.002
	AE 4158
	CIRCUIT PROTECTION VALVE

	05.02.004
	AE 4162
	CIRCUIT PROTECTION VALVE

	05.02.009
	AE 4609
	CIRCUIT PROTECTION VALVE

	05.05.001
	201.002.001
	TRAILER CONTROL VALVE

	12.01.021
	973.011.200.0
	RELAY VALVE

OTHER PRODUCTS

	12.02.001
	973.006.003.0
	RELAY VALVE

	12.02.002
	973.006.000.0
	RELAY VALVE

	12.02.003
	973.006.001.0
	RELAY VALVE

	78.01.003
	0.484.451.013
	ALCOHOL VALVE

	11.01.001
	475.715.500.0 1506232 CF352132
	LOAD SENSING RELAY EMERGENCY VALVE

	RK.11.004
	475.715.500.2
	LOAD SENSING RELAY EMERGENCY VALVE REPAIR KIT

	11.01.002
	475.712.500.0 1325324 BBU8129
	LOAD SENSING RELAY EMERGENCY VALVE

	RK.11.002
	475.712.000.2
	LOAD SENSING RELAY EMERGENCY VALVE REPAIR KIT

	11.01.005
	475.710.136.0
	LOAD SENSING RELAY EMERGENCY VALVE

	RK.11.006
	475.710.001.2
	LOAD SENSING RELAY EMERGENCY VALVE REPAIR KIT

OTHER PRODUCTS

	11.02.001
	475.604.010.0 127.1399 81.52161.6174
	LOAD APPORTIONING VALVE

RK.11.005	
475.604.002.2	
LOAD APPORTIONING VALVE REPAIR KIT	

	04.01.001
	461.315.008.0 85.50001.4354 001.431.8305
	FOOT BRAKE VALVE

RK.04.001	
461.315.005.2	
FOOT BRAKE VALVE REPAIR KIT	

	04.02.001
	461.319.008.0
	FOOT BRAKE VALVE

RK.04.002	
461.319.007.2	
FOOT BRAKE VALVE REPAIR KIT	

	20.01.001
	SV 3367
	GEARBOX VALVE

RK.20.007	
GEARBOX VALVE REPAIR KIT	

	20.01.003
	3092123 1669324 1869324
	GEARBOX VALVE

RK.20.001	
GEARBOX VALVE REPAIR KIT	

OTHER PRODUCTS

	20.01.004
	1068952
	GEARBOX VALVE

RK.20.018	
GEARBOX VALVE REPAIR KIT	

	20.01.016
	1068951
	GEARBOX VALVE

RK.20.010	
GEARBOX VALVE REPAIR KIT	

	20.01.008
	SV 3302
	GEARBOX VALVE

RK.20.003	
GEARBOX VALVE REPAIR KIT	

	20.01.011
	002.260.2457
	GEARBOX VALVE

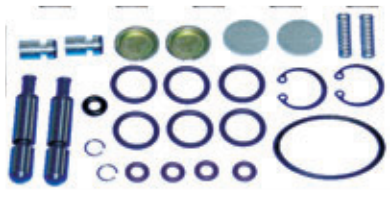
RK.20.013	
GEARBOX VALVE REPAIR KIT	

	20.01.007
	1319557
	GEARBOX VALVE

20.01.004	
1669297	
GEARBOX VALVE	

OTHER PRODUCTS

	04.02.005
	463.032.020.0 000.327.5125 81.43616.6004 42089956
	ROTARY SLIDE VALVE

04.02.010	
HB 1176	
ROTARY SLIDE VALVE	

	12.03.007
	SV 3111
	ROTARY SLIDE VALVE

12.03.012	
SV 3115	
ROTARY SLIDE VALVE	

	06.04.016
	464.007.002.0
	LEVELLING VALVE

20.01.005	
SV 3371	
GEARBOX VALVE	

	20.01.009
	1334037
	GEARBOX VALVE

20.01.010	
1303948	
GEARBOX VALVE	

	83.01.001
	0.481.009.022
	PRESSURE ADJUSTMENT VALVE

51.01.006	
DR 5118	
PRESSURE VALVE	

OTHER PRODUCTS

	22.01.001
	463.036.000.0 001.997.5036 81.52185.6015
	DIRECTIONAL CONTROL VALVE

21.01.001	
473.501.001.0	
QUICK RELEASE VALVE	

	35.01.001
	BZ 6621
	BRAKE ACTUATOR Ø125

35.01.002	
BZ 6517	
BRAKE ACTUATOR Ø115	

	20.05.001
	000.267.0519
	HOUSING SHIFTING CYLINDER

89.01.001	
STEERING WHEEL PUMP	

	77.01.001
	403.184.1108
	OIL RADIATOR HEAD

25.01.001	
624.300.0304	
THE RATTLE PEDAL KIT	

	13.01.001
	000.268.4889 000.268.5289
	BALL JONT RIGHT

13.01.002	
000.268.4689 000.268.6289	
BALL JONT LEFT	

OTHER PRODUCTS

	53.01.001
	371.501.8082
	INTERCOOLER AIR HOSE INNERDIA 25-21

53.01.002	
81.96301.0587	
INTERCOOLER AIR HOSE INNERDIA MAN 422	

	53.01.003
	002.094.6682
	INTERCOOLER AIR HOSE INNERDIA ACTROS

53.01.004	
81.96301.0668	
INTERCOOLER AIR HOSE INNERDIA MAN 463	

	53.01.005
	002.094.5282
	INTERCOOLER AIR HOSE INNERDIA MERCEDES 30- 31

53.01.006	
002.094.6382.b	
INTERCOOLER AIR HOSE INNERDIA MRCEDES O403	

	53.01.007
	486.5230.EZ.4.GP
	INTERCOOLER AIR HOSE INNERDIA IVECO

65.01.001	
000.295.1715	
AIR FILTER LEVELLING RUBBER	

	69.01.002
	0.481.062.413
	STEERING WHEEL HYRUEALIC CUP

07.02.001	
000.090.6050	
FUEL FILTER	

OTHER PRODUCTS

	18.01.001
	FULLER GEAR SHIFT HANDLE
	ONE CIRCUIT

18.01.002	
463.053.107.0	
FULLER GEAR SHIFT HANDLE	
TWO CIRCUITS	

	18.02.001
	81.97010.6011
	MAN GEAR MACE
ONE CIRCUIT	

18.02.002	
81.97010.6009	
MAN GEAR MACE	
TWO CIRCUITS	

	18.02.003
	81.32620.0043
	MAN GEAR MACE

18.02.004	
81.32620.0045	
MAN GEAR MACE	

	15.01.001
	620.490.0365
	FLEXIBLE HOSE Ø80

15.01.002	
620.490.0465	
FLEXIBLE HOSE Ø95	

	15.01.003
	621.490.0065
	FLEXIBLE HOSE Ø105

63.01.001	
FLEXIBLE HOSE	

OTHER PRODUCTS

	74.01.002
	000.092.4708
	FILTER HEAD SMALL

74.01.003	
541.184.0208	
FILTER HEAD BIG	

	74.01.004
	51.05505.6002
	FILTER HEAD

74.01.005	
51.12504.6003 000.092.5208	
FILTER HEAD	

	62.01.001
	000.476.0068
	EXPANSION COVER

62.01.002	
000.476.0068	
EXPANSION COVER	

	08.05.001
	641.810.0012
	MIRROR BRACKET BOTTOM

08.06.002	
000.810.1025	
MIRROR BRACKET BOTTOM	

	08.05.002
	MIRROR BRACKET

08.01.001	
381.811.1236	
MIRROR BRACKET	



Showroom-Satış: Konsan Özel Sanayi Bölgesi Fevzi Çakmak Mahallesi
10728 Sokak No:3 Karatay/Konya/TÜRKİYE
Tel:+90 332 346 02 50 // Faks:+90 332 346 02 51

Fabrika: Ankara Yolu Üzeri Konsan Özel Organize Sanayi Bölgesi Fevzi
Çakmak Mahallesi 10753 Sokak No:16 Karatay/Konya/TÜRKİYE
Tel: +90 332 346 36 60 // Faks: +90 332 346 36 65

info@mehmetyumak.com // satis@mehmetyumak.com
www.mehmetyumak.com